



Operating Instructions for Digital Pressure Gauge

Model: MAN-SC/-LC



MAN-LC



MAN-SC



We don't accept warranty and liability claims neither upon this publication nor in case of improper treatment of the described products.

The document may contain technical inaccuracies and typographical errors. The content will be revised on a regular basis. These changes will be implemented in later versions. The described products can be improved and changed at any time without prior notice.

© **Copyright**

All rights reserved.

1. Contents

1. Contents.....	2
2. Note	4
2.1 Notes on the machine and pressure equipment directive	4
3. Instrument Inspection.....	4
4. Regulation Use	4
5. Operating Principle.....	5
6. Mechanical Connection.....	5
6.1 Orientation of the electronics housing.....	7
7. Electrical Connection	8
7.1 Inserting or changing the battery at MAN-SC	8
7.2 Electrical connection with MAN-LC.....	8
8. Layout of the LC display.....	9
9. Button function	10
9.1 Menu operation.....	11
10. Menu function – menu levels	12
10.1 Menu levels.....	12
11. Power management (MAN-SC)	13
11.1 Display of the battery status.....	13
11.2 Sleeping mode.....	14
12. Display orientation.....	15
13. Display functions.....	17
13.1 Display overflow.....	17
13.2 Measuring overrange.....	17
13.3 MIN / MAX memory function.....	18
13.4 Force reading.....	18
14. Electrical outputs (only MAN-LC)	19
14.1 Display of the output configuration.....	19
14.2 IO-Link Function MAN-LC.....	19
15. Device parameterization	20
15.1 Parameter table MAN-LC.....	20
15.2 Parameter table MAN-SC	24
15.3 Process of device parameterization.....	25
15.4 Display (main menu DISP).....	26

15.5 Other (main menu MISC).....	26
15.6 Measurement (main menu MEAS).....	27
15.7 Outputs (main menu OUT1, OUT2, only MAN-LC).....	28
15.8 User service (main menu USER).....	35
15.9 Factory service (main menu FACT).....	35
15.10 Info (main menu INFO).....	36
16. Maintenance	36
16.1 Notice According to the Battery Law.....	36
17. Technical Data	37
18. Device delivery status	39
19. Order codes	40
20. Dimensions	43
21. IO-Link manufacturer's declaration	45
22. EU Declaration of Conformity.....	46
1. Appendix IO-Link specification MAN-LC	47
1.1 IO-Link process data structure.....	47
1.2 IO-Link diagnostic information	47
1.3 IO-Link system command table	48
1.4 IO-Link ISDU parameter table	48

Manufactured and sold by:

KOBOLD Instruments Inc.
1801 Parkway View Drive
Pittsburgh PA 15205-1422
Tel.: 412-788-2830
Fax: 412-788-4890
E-Mail: info.@koboldusa.com
Internet: <http://koboldusa.com>

2. Note

Please read these operating instructions before unpacking and putting the unit into operation. Follow the instructions precisely as described herein.

The devices are only to be used, maintained and serviced by persons familiar with these operating instructions and in accordance with local regulations applying to Health & Safety and prevention of accidents.

When used in machines, the measuring unit should be used only when the machines fulfil the EC-machine guidelines.

2.1 Notes on the machine and pressure equipment directive

When used in machines, the measuring unit should be used only when the machines fulfil the EC-machine guidelines.

as per PED 2014/68/EU

"Pressure gauges with a volume ≤ 0.1 L"

In acc. with Article 4 Paragraph (3), "Sound Engineering Practice", of the PED 2014/68/EU no CE mark.

Diagram 2

Vessels referred to in Article 4(1)(a)(i), second indent

3. Instrument Inspection

Instruments are inspected before shipping and sent out in perfect condition.

Should damage to a device be visible, we recommend a thorough inspection of the delivery packaging. In case of damage, please inform your parcel service / forwarding agent immediately, since they are responsible for damages during transit.

Scope of delivery:

The standard delivery includes:

- Digital Pressure Gauge model: MAN-SC/-LC
- Operating Instructions
- MAN-SC only: 9 V block battery (IEC 6 LR 61)

4. Regulation Use

Any use of the device, which exceeds the manufacturer's specification, may invalidate its warranty. Therefore, any resulting damage is not the responsibility of the manufacturer. The user assumes all risk for such usage.

5. Operating Principle

The devices of the type MAN-SC / -LC are used for measuring, monitoring and remote transmission of pressure-dependent operating processes in machines and systems.

The devices are equipped as follows:

- 5-digit LCD display
- Three programming buttons
- Process connection made of stainless steel
- Peak value memory
- Analog output, frequency output, switching output (MAN-LC)
- IO-Link function (MAN-LC)
- for MAN-SC: power supply via 9 V block battery
- for MAN-LC: external power supply via 24 VDC

The pressure to be measured is recorded by a ceramic sensor (>700 bar metal cell) and displayed via the electronics. At the same time, two electrical outputs are available at which various output functions can be parameterized (MAN-LC).

6. Mechanical Connection

Before installation:

- Make sure that the maximum pressure in your system is within the measuring range of the digital manometer. The measuring range can be read on the nameplate.
- Make sure that the maximum permissible operating temperatures of the device are not exceeded.
- Make sure that there are no packaging parts in the device.

MAN-SC/-LC

Installation:

- Make sure that the pressure line is depressurized.
- The digital manometer is mounted like a mechanical manometer.
- The thread connection is either NPT, G thread (sealed with a suitable seal, flat seal, or sealing ring according to DIN 16258), or other type (Mxx or UNF).
- When tightening the device, don't turn using the housing, use the hexagon (24mm) process connection. Only use open-ended wrenches for assembly!
- If possible, check after the mechanical installation whether the connection screw connection / pipe is tight.

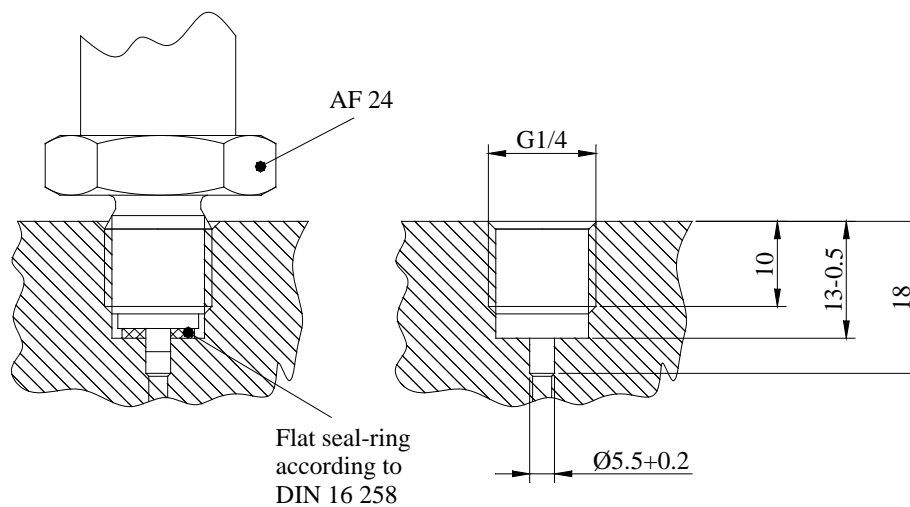

Note: After each mechanical installation of the sensor, a zero point is required.
(Menu item MISC / OFFSET, not for instruments with absolute pressure ranges).

6.1 Orientation of the electronics housing



The electronics housing can be rotated by max. 180° in both directions. To do this, loosen the lock nut above the sensor housing, rotate the electronics, and tighten the locknut again. Warning: a rotation greater than 180° in one direction will tear the sensor connection wires and destroy the device.

7. Electrical Connection



Attention! Incorrect wiring will lead to damage of the unit's electronics.

7.1 Inserting or changing the battery at MAN-SC

To insert or replace the battery, the rear cover of the MAN-SC must be turned 1/4 turn to the left in order to open the bayonet lock. The cover can then be removed from the rear and the battery compartment is accessible. The new battery must be correctly attached to the existing battery clip according to the contacts. The battery must be placed in the battery compartment. Before closing the cover, make sure that the O-ring seal is correctly seated in the corresponding groove in the cover. The rear cover must be hand-tightened to close so that it does not loosen from vibration on the device.

7.2 Electrical connection with MAN-LC

Connection	MAN-LC30
Supply voltage +Vs	M12x1 PIN 1
Supply voltage GND	M12x1 PIN 3
Output 1	M12x1 PIN 4
Output 2	M12x1 PIN 2
Not used	M12x1 PIN 5

8. Layout of the LC display

MAN-SC

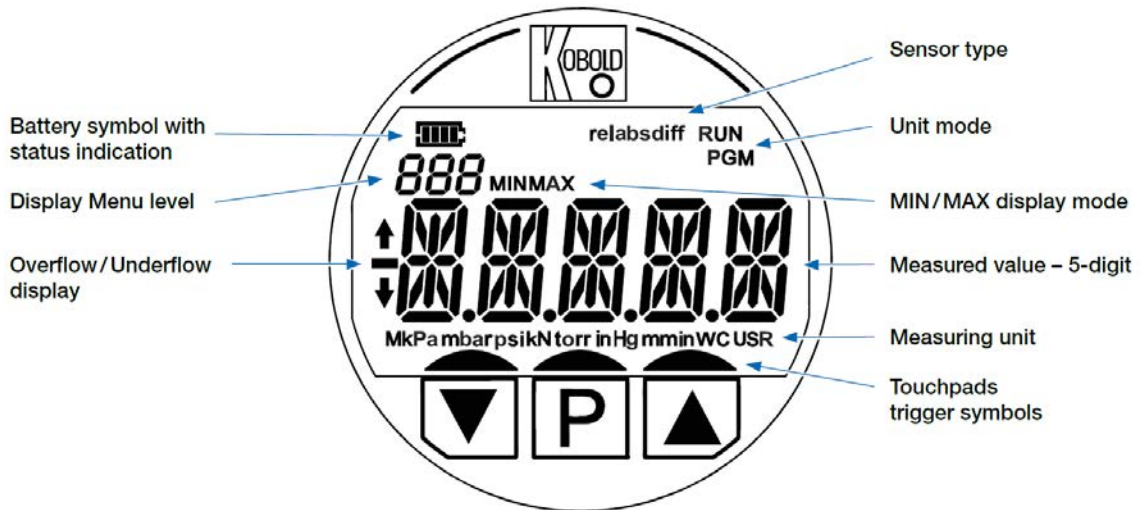

MAN-LC

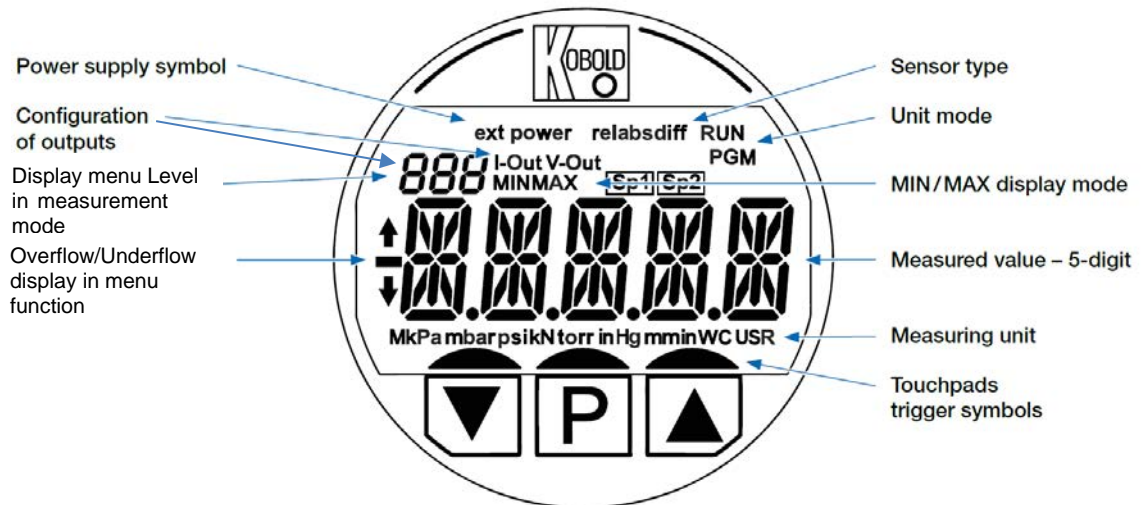

9. Button function

The 3 buttons below the display section are operated by placing your finger directly on the display panel. The active key areas are shown by the boundary lines.

The button functions are optimized for finger operation, operation with gloves is not possible. Adhering or standing drops of water on the keypads can interfere with the key function.

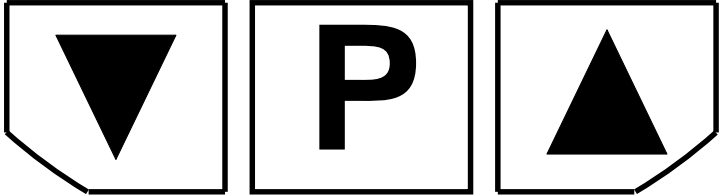
Operating condition	Key stroke			
Measuring function (RUN display)	Long	Display of MIN measured values	Call up menu function	Display of MAX measured values
Menu function (PGM display)	Short	Select value downwards (DOWN)	Confirm / save selection	Select value upwards (UP)
	Long	x	Back one menu level / exit the menu function	x

After each recognizable triggering of a key function, lift finger from the key surface in order to be able to trigger another key function (long or short).

The P key can be used to navigate in the settings menu: Short button press: Confirm selection or call up a submenu. Long press: Leave the current menu level and switch to the higher-level menu level

9.1 Menu operation

Menu operation

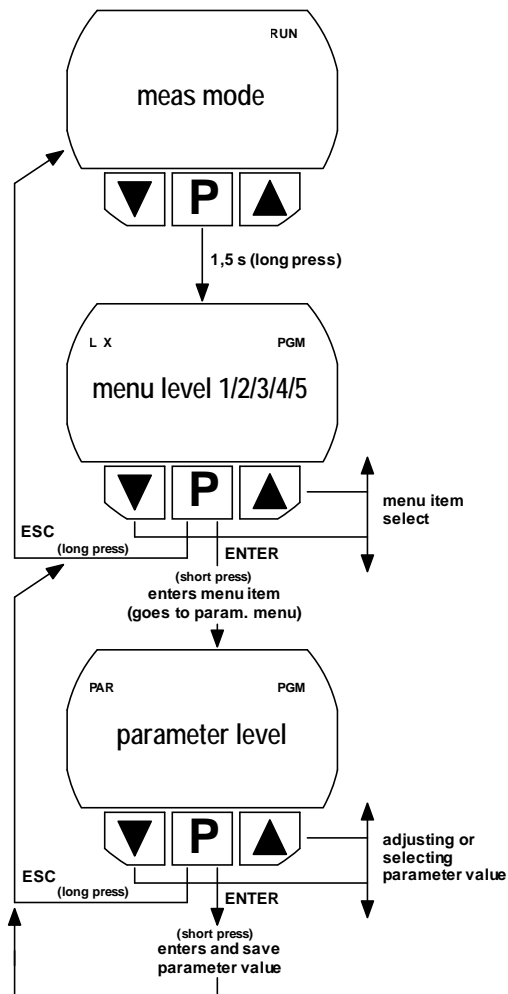

Menu level - value adjuster

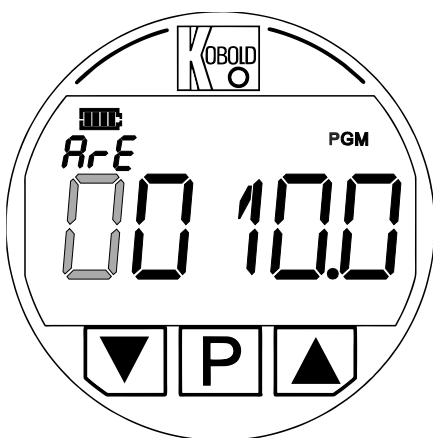

In the parameter level, the parameters are set either via a list selection or directly via a value adjuster.

The number of decimal places is fixed for each parameter with a value adjuster.

If the value adjuster is called up, the left adjustable digit flashes first. The numerical value can be changed with the UP or DOWN button. The next right digit can be set by briefly pressing the P key. The adjustable position can be moved to the left again by pressing and holding the P button.

If the last digit on the right is set (for many parameters up to 3 decimal places), the parameter value is saved by confirming with the P key and the value adjuster is exited.

For parameters with more than 5 adjustable locations, the display section is shifted to the right by selecting the adjustable location by a location to the right until the smallest adjustable location is displayed.

10. Menu function – menu levels

10.1 Menu levels



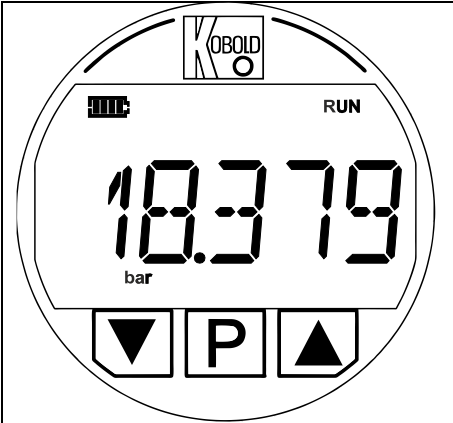
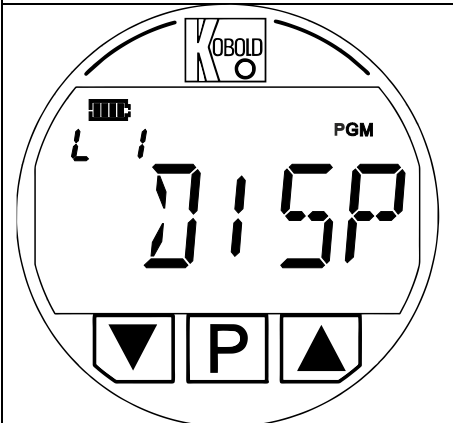
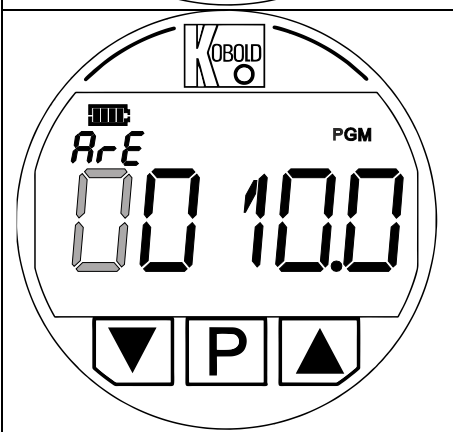

If the P key is pressed for longer than 3 seconds, the device changes from measuring mode (RUN display symbol) to menu mode (PGM display symbol).

 <p>The image shows a circular digital display with the KOBOLD logo at the top. Below the logo is a battery level indicator and the word 'RUN'. The main display shows the number '18.379' with 'bar' underneath. At the bottom, there are three buttons: a downward arrow, a 'P' key, and an upward arrow.</p>	<p>Measuring mode</p>
 <p>The image shows the same circular display with the KOBOLD logo. Below the logo is a battery level indicator and the word 'PGM'. The main display shows 'L 1' followed by '015P'. At the bottom, there are three buttons: a downward arrow, a 'P' key, and an upward arrow.</p>	<p>Menu level Level 1 - 5</p>
 <p>The image shows the same circular display with the KOBOLD logo. Below the logo is a battery level indicator and the word 'PGM'. The main display shows 'ArE' followed by '00 10.0'. At the bottom, there are three buttons: a downward arrow, a 'P' key, and an upward arrow.</p>	<p>Parameter level (List selection or value entry)</p>

11. Power management (MAN-SC)

11.1 Display of the battery status

The battery life is indicated by the number of segments in the battery symbol. Depending on the type of battery used and the ambient temperature, the display can be inaccurate or fluctuate by 1 segment. The battery status display is matched to the discharge characteristics of alkaline battery types.

Symbol	Status	Note
	$\geq 80\%$	-
	$\geq 60\% \dots < 80\%$	-
	$\geq 40\% \dots < 60\%$	-
	$\geq 20\% \dots < 40\%$	-
	$< 20\%$	Change the battery if necessary!

11.2 Sleeping mode

For the purpose of maximizing the service life of the battery, automatic sleep mode activation can be set in the device, which puts the device into sleep mode after an adjustable time without pressing a button. If sleep mode is active, the device can be woken up again at any time by pressing a button. There are 3 different sleep modes available, which lead to different energy savings and serve different purposes.

Setting parameters in the menu: DISP / SLEEP or DISP / TOFF

Sleep mode	Description	Power consumption *	Note
-	-	~ 55 μ A	Normal measuring mode, parameter TOFF = 0
0	Display is switched off	~ 45 μ A	Low power savings through display switch-off, measurement continues
1	The display is switched off and the measurement is stopped	~ 20 μ A	Fast operational readiness after waking up (1 to 2 s)
2	Device in deepest sleep mode. No measuring function	~ 13 μ A	Device restarts after waking up. Operational readiness after approx. 5 s. Suitable for storage of devices with inserted battery

*: Average power consumption from a 9V battery

12. Display orientation

The electronic display of the MAN-SC / MAN-LC can be rotated by the user in 90° steps in order to adapt the display direction to the installation position:

- Unscrew the display screw ring
- Carefully remove the electronics unit from the electronics housing (note the limited cable length of the sensor and M12x1 connector!)
- Turn the electronics unit and reinsert it in the specified locking position
- Screw on the screw ring again (tightening torque max. 3 Nm)

Attention: The electronics unit may be rotated by a maximum of 180° in one direction, otherwise there is a risk that the connecting wires will be torn out of the terminals!

The electronics module is connected to the sensor and connector or battery clip as follows:

MAN-SC

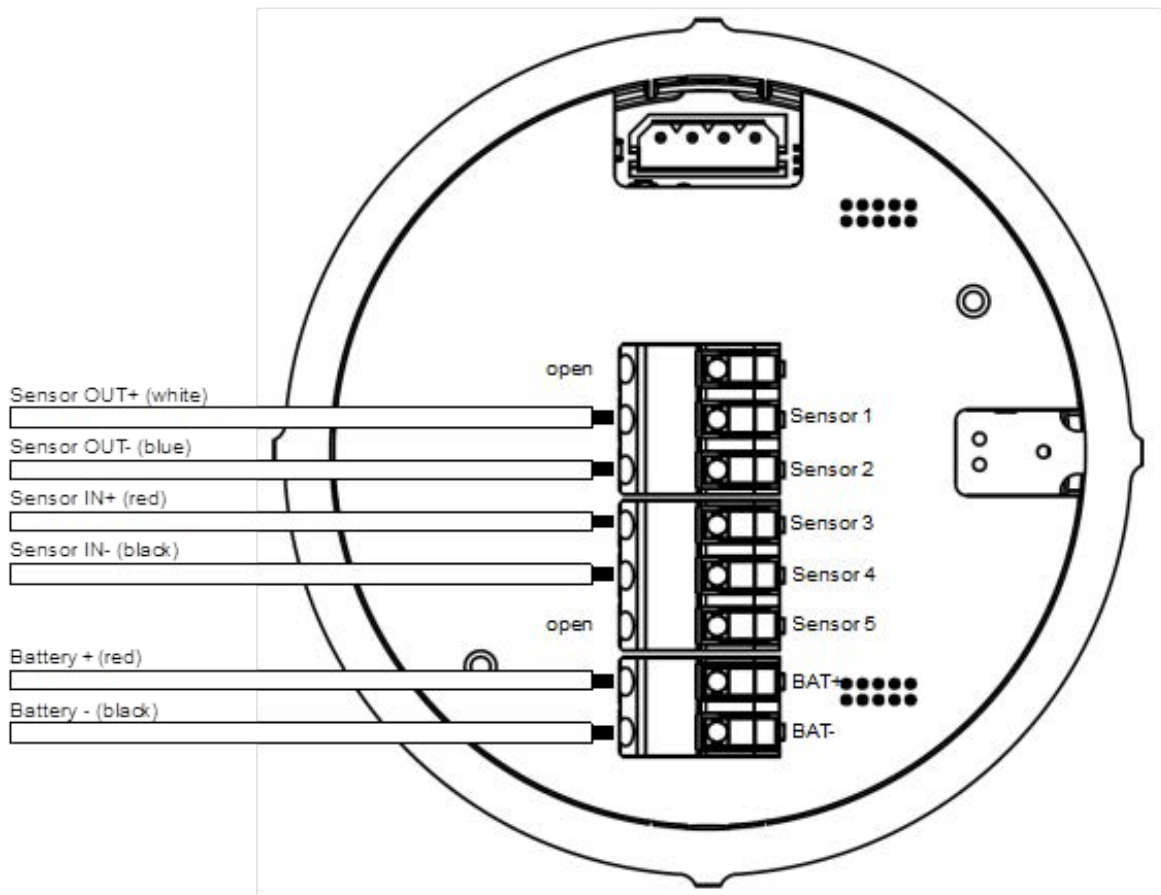

MAN-SC/-LC

MAN-LC

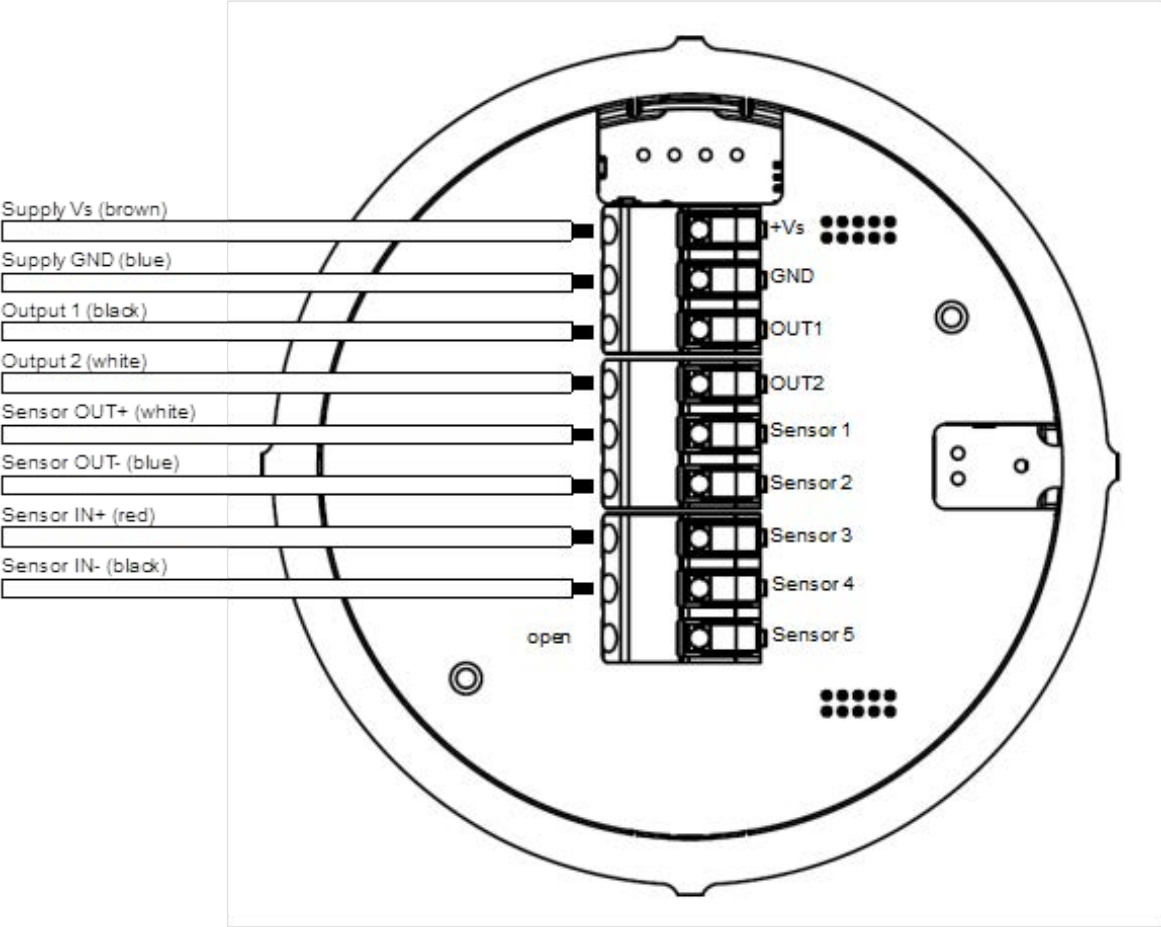

13. Display functions

13.1 Display overflow

The measured value display has a display area of +/- 99999 (5 digits). The display of the measured values is always 5-digits. The number of pre-decimal places defines the number of decimal places displayed: pre-decimal places + decimal places = 5. The max. Number of decimal places is limited to 4.

Pre-decimal position [V]	Decimal positions [N]	Display
0	4	0,NNNN
1	4	V,NNNN
2	3	VV,NNN
3	2	VVV,NN
4	1	VVVV,N
5	0	VVVVV

If the measured value exceeds 5 pre-decimal positions, the display shows 5 strokes in the display for displaying the display overflow (- - - -). This may occur if e.g. the display unit of a measured value is changed to a small unit. Accordingly, the display overflow can be prevented or remedied when a larger display unit is selected.

13.2 Measuring overrange

If the measured value exceeds the final value of the measuring range by more than 5% of the measuring range span, the overflow symbol (↑) is shown on the display to the left of the measured value. In the same way, the underflow symbol (↓) is displayed as long as the measured value is at least 10% of the measuring range span below the measuring range start value.

Status	Condition
Overflow (↑)	Measured value > MBE + (MBA - MBE)*0.05
Underflow (↓)	Measured value < MBA - (MBA - MBE)*0.05

13.3 MIN / MAX memory function

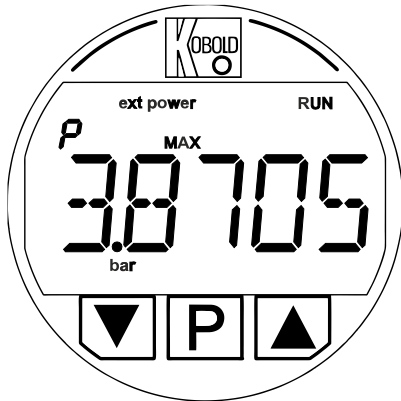

The MAN-SC / -LC devices have a peak value storage function as standard. For both measured values pressure and force, the minimum and maximum measured value is continuously recorded and saved. The respective MIN or MAX values are displayed by pressing and holding the UP or DOWN key in the measuring mode.

Measuring mode	
MIN display function	MAX display function
▼	▲
Reset MIN / MAX memory	
P	

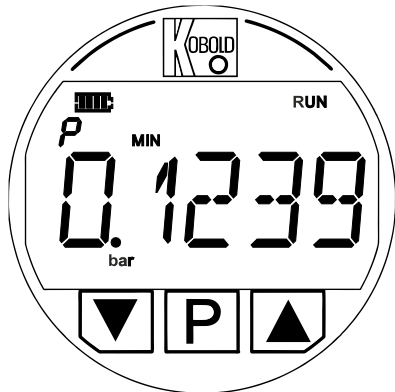

If the MIN or MAX display function is activated, the corresponding values for pressure and force are displayed alternately for 5 seconds each. During this time, the corresponding memory can be reset to the current measured value by pressing the P key for a longer period of time.

After switching off the supply voltage or changing the battery, the MIN / MAX values are retained in the internal memory.

13.4 Force reading

Calculation of the force measurement value F

The measured value for force is converted using the pressure measured value and a reference surface (AREA parameter):

$$Force [N] = 10 \times AREA \times \text{measured pressure value}$$

with $AREA = \text{reference area in [mm}^2\text{]}$
and $\text{pressure measured value in [bar]}$

14. Electrical outputs (only MAN-LC)

14.1 Display of the output configuration

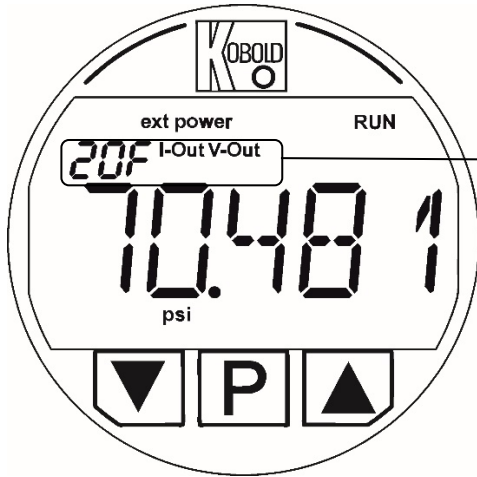

In measuring mode, the configuration of the electrical outputs for output 1 and output 2 is shown alternately in the small 3-digit 7-segment display on the MAN-LC. The display coding can be found in the table.

If output 2 is configured as a current output, the "I-OUT" symbol is permanently displayed, if output 2 is configured as a voltage output, the "V-OUT" symbol is permanently displayed.

Digit 1 Exit no.	Digit 2 Output type 1	Digit 3 Output type 2	Function
1	0	F	Output 1 deactivated
1	I	0	Output 1 IO-Link (factory setting)
1	–	F	Output 1 frequency output
1	S	P	Output 1 switching output
1	K	0	Output 1 KofiCom (only for factory settings)
1	–	C	Output 1 control input
2	0	F	Output 2 deactivated (factory setting)
2	A	4	Output 2 4-20mA
2	A	0	Output 2 0-20mA
2	V	0	Output 2 0-10VDC
2	V	2	Output 2 2-10VDC
2	–	F	Output 2 frequency output
2	S	P	Output 2 switching output

14.2 IO-Link Function MAN-LC

The MAN-LC pressure sensor has an IO-Link communication interface as standard. The process and diagnostic data can be accessed directly via this interface and the device can be parameterized.

The IO-Link interface can be used if OUT1 is manually configured to "IO-Link" in the settings menu.

So that the IO-Link device can be operated correctly on the connected IO-Link master, it is necessary to install the device description file that matches the device. The device description files (IODD) are available in the IODDfinder, ioddfinder.io-link.com.

Further information on IO-Link is available on the homepage www.io-link.com.

15. Device parameterization

15.1 Parameter table MAN-LC

Menu level					Description	Parameter value range	Parameter default value	
Level 1	Level 2	Level 3	Level 4	Level 5				
DISP	REFRE				Display refresh rate	1 - 10 s	1 s	
	LAY	SING			Permanently shows the measured value configured under DISPV / FIRST	-	SING	
		ALTE			Alternately displays the two measured values configured under DISPV	-		
	DISPV	FIRST			Measured value for first display	P, F	P	
		SECON			Measured value for second display	P, F	F	
	M OUT				If the value > 0, the setting menu is exited automatically after [VALUE] s	0 - 60 s (0 = Off)	0	
MISC	OFSET**				If YES is confirmed, sets the current pressure measurement value as the zero point (duration of the calibration function: 5 sec.)	NO / YES	NO	
	AREA				Reference area in [mm ²] with which the measured pressure value P is converted into the measured force value F.	0 – 9999,9	10,0	
MEAS	0: P 2: F	UNIT			Measurement unit, selection via display symbols USR = user unit Input value P = [USR] / [bar] Input value F = [USR] / [N]	P: bar/mbar/Pa/ kPa/MPa/psi/torr/ inchHg/mmWC/ inchWC/USR F: N/kN/USR	P: bar F: N	
		SIM	ACT*			Simulation activation Simulation switches off after SIM auto-stop time (see USER menu)	DIABL / ENABL	DIABL
	MODE		STATI		Constant value	STATI / TRIAN / MONO	STATI	
			TRIAN		Value progression in triangular form			
			MONO		Monotonically increasing value			
	S VAL		Start value for MONO and TRIAN			MBA ... MBE [Unit]	0,00	
	I VAL		Interval increment (not for STATI mode)			MBA ... MBE [Unit]	10,00	
	INTER		Number of intervals (not for STATI mode)			0 - 65000	20	

Menu level					Description	Parameter value range	Parameter default value			
Level 1	Level 2	Level 3	Level 4	Level 5						
			TIME		Time between intervals (not for STATI mode)	0 - 50000 [ms]	50 ms			
OUT1	0: P 2: F	DISAB				Output deactivated				
		ALAR M	FUNC	LIMIT		Limit value function	LIMIT / WINDO	LIMIT		
				WIND O		Window function				
			TYPE				Physical output type: NPN = negative switching, PNP = positive switching, PP = switching on both sides (PushPull)	NPN / PNP /PP	NPN	
			SWI				Logical output function NO = normally open function, NC = normally closed function	NO / NC	NO	
			THRE				Switching threshold	MBA - MBE [Unit]	1,000	
			LTHRE				Lower switching threshold (only with activated window function)	MBA - MBE [Unit]	1,000	
			HYST				Hysteresis	MBA - MBE [Unit]	1,000	
			SUPPR				Switching delay factor (x100ms)	0 - 60	0	
			SU DI				Switching delay direction up / down / both sides	UP/DOWN/ BOTH	UP	
			FREQ	MAXF				Measured value at which MAXHZ is output	[0HZ] - MBE [Unit]	100,0
		OVERF				Overflow in% of MAXF	0 - 100 [%]	1		
		0HZ				Measured value at which 0 Hz is output	MBA - [MAXF] [Unit]	0,00		
		MAXHZ				Output frequency for measured value MAXF	0 - 1000 [Hz]	100,00		
		KOFIC				KofiCom communication mode	-	-		
		IOLIK				IO-Link communication mode	-	-		
		CTLI N	FUNC				Function control input Off / MIN-MAX memory reset	OFF / M RST	OFF	
		OUT2	0: P 2: F	DISAB				Output deactivated		
				ALAR M	FUNC	LIMIT		Limit value function	LIMIT / WINDO	LIMIT
						WIND O		Window function		
TYPE				Physical output type: NPN = negative switching, PNP = positive switching, PP = switching on both sides	NPN / PNP /PP	NPN				

MAN-SC/-LC

Menu level					Description	Parameter value range	Parameter default value
Level 1	Level 2	Level 3	Level 4	Level 5			
			SWI		Logical output function NO = normally open function, NC = normally closed function	NO / NC	NO
			THRE		Switching threshold	MBA - MBE [Unit]	1,000
			HYST		Hysteresis	MBA - MBE [Unit]	1,000
			SUPPR		Switching delay factor (x100ms)	0 - 60	0
			SU DI		Switching delay direction up / down / both sides	UP/DOWN/ BOTH	UP
		4-20	NAMUR		Activates output overflow and underflow behavior according to NAMUR	ENABL / DIAB	ENAB
			4MA		Measurement value for 4mA output current (20MA value must be greater than 4MA value)	MBA - [20MA] [Unit]	MBA
			20MA		Measured value for 20mA output current (20MA value must be greater than 4MA value)	[4MA] - MBE [Unit]	MBE
		0-20	NAMUR		Output overflow and underflow behavior according to NAMUR	ENABL / DIAB	ENAB
			0MA		Measurement value for 0mA output current (20MA value must be greater than 0MA value)	MBA - [20MA] [Unit]	MBA
			20MA		Measured value for 20mA output current (20MA value must be greater than 0MA value)	[0MA] - MBE [Unit]	MBE
		2-10V	NAMUR		Output overflow and underflow behavior according to NAMUR	ENABL / DIAB	ENAB
			2V		Measured value for 2V output voltage (10V value must be greater than 2V value)	MBA - [10V] [Unit]	MBA
			10V		Measured value for 10VA output voltage (10V value must be greater than 2V value)	[2V] - MBE [Unit]	MBE
		0-10V	NAMUR		Output overflow and underflow behavior according to NAMUR	ENABL / DIAB	ENAB
			0V		Measured value for 0V output voltage (10V value must be greater than 0V value)	MBA - [10V] [Unit]	MBA

Menu level					Description	Parameter value range	Parameter default value
Level 1	Level 2	Level 3	Level 4	Level 5			
			10V		Measured value for 10VA output voltage (10V value must be greater than 0V value)	[0V] - MBE [Unit]	MBE
		FREQ	MAXF		Measured value at which MAXHZ is output	[0HZ] - MBE [Unit]	100,0
			OVERF		Overflow in % of MAXF	0 - 100 [%]	1
			0HZ		Measured value at which 0 Hz is output	MBA - [MAXF] [Unit]	0,00
			MAXHZ		Output frequency for measured value MAXF	0 - 1000 [Hz]	100,00
USER	PASSW				Defines the USER menu password (00000 = USER menu open)	00000 - 99999	00000
	FACRS				If YES resets all parameters to the factory setting	NO / YES	NO
	MLOCK				Activates the password query when entering the menu	ULOCK / LOCK	ULOCK
	SAS				Simulation of auto stop time. Specifies the time in minutes after which the simulation is automatically ended	1 - 31 min	10
FACT	PASSW				Factory settings menu, password protected (access only for service purposes)		
INFO	GEN				General device information	MAN-SC / MAN-LC	-
	VER				Firmware version	Vxx.xx	-
	REV				Firmware revision	##### (Release date)	-

* The ACT parameter must be set to ENABLED so that the other parameters are displayed

** The offset function is not available for devices with an absolute pressure sensor

MAN-SC/-LC

15.2 Parameter table MAN-SC

Menu level					Description	Parameter value range	Parameter default value	
Level 1	Level 2	Level 3	Level 4	Level 5				
DISP	REFRE				Display refresh rate	1 - 10 s	1 s	
	SLEEP				Sleep mode	0,1,2	0	
	TOFF				TimeOut time	0 - 120 min.	0 (AUS)	
	LAY	SING				Permanently shows the measured value configured under DISPV / FIRST	-	SING
		ALTE				Alternately displays the two measured values configured under DISPV	-	
	DISPV	FIRST				Measurement type for first display	P, F	P
		SECON				Measurement type for second display	P, F	F
M OUT				If the value > 0, the setting menu is exited automatically after [VALUE] s	0 - 60 s (0 = Aus)	0		
MISC	OFSET**				If YES is confirmed, sets the current pressure measurement value as the zero point (duration of the calibration function: 5 sec.)	NO / YES	NO	
	AREA				Reference area in [mm ²] with which the measured pressure value P is converted into the measured force value F.	0 – 9999,9	10,0	
MEAS	0: P 2: F	UNIT			Measurement unit, selection via display symbols USR = user unit Input value P = [USR] / [bar] Input value F = [USR] / [N]	P: bar/mbar/Pa/ kPa/MPa/psi/torr/ inchHg/mmWC/ inchWC/USR F: N/kN/USR	P: bar F: N	
		SIM	ACT*		Simulation activation Simulation switches off after SIM auto-stop time (see USER menu)	DIABL / ENABL	DIABL	
			MODE	STATI	Constant value	STATI / TRIAN / MONO	STATI	
				TRIAN	Value progression in triangular form			
				MONO	Monotonically increasing value			
S VAL		Start value for MONO and TRIAN	MBA ... MBE [Unit]	0,00				

Menu level					Description	Parameter value range	Parameter default value
Level 1	Level 2	Level 3	Level 4	Level 5			
			I VAL		Interval increment (not for STATI mode)	MBA ... MBE [Unit]	10,00
			INTER		Number of intervals (not for STATI mode)	0 - 65000	20
			TIME		Time between intervals (not for STATI mode)	0 - 50000 [ms]	50 ms
USER	PASSW				Defines the USER menu password (00000 = USER menu open)	00000 - 99999	00000
	FACRS				If YES resets all parameters to the factory setting	NO / YES	NO
	MLOCK				Activates the password query when entering the menu	ULOCK / LOCK	ULOCK
	SAS				Simulation of auto stop time. Specifies the time in minutes after which the simulation is automatically ended	1 - 31 min	10
FACT	PASSW				Factory settings menu, password protected (access only for service purposes)		
INFO	GEN				General device information	MAN-SC / MAN-LC	-
	VER				Firmware version	Vxx.xx	-
	REV				Firmware revision	##### (Release date)	-

* The ACT parameter must be set to ENABLED so that the other parameters are displayed

** The offset function is not available for devices with an absolute pressure sensor

15.3 Process of device parameterization

The MAN-SC / -LC pressure sensor is pre-parameterized at the factory. In the event of subsequent changes to pressure or force measurement units, the parameters that depend on this are converted and adjusted accordingly. The limit value parameters of the switching outputs must, however, be checked and adjusted by hand when adjusting pressure and force units - these are not automatically converted. An inadvertent change to the parameterization can be revised using the "Reset factory settings" function in the USER / FACRS menu.

15.4 Display (main menu DISP)

15.4.1 Refresh

The "Refresh" parameter defines the time interval within which the measurement variables are displayed. The "refresh rate" can be increased in steps from 1 s to 10 s. An increase in the refresh rate time causes an increased "filtering" of the display value.

15.4.2 Sleep mode (parameters SLEEP and TOFF, only MAN-SC)

See section 10.2

15.4.3 Display layout (LAY submenu)

Here you can select whether 1 measured value (SING) or 2 measured values (ALTE) are displayed alternately.

15.4.4 Display value (DISPV parameter)

With the help of this parameter, the measurement variables made available by the transducer can be displayed. Depending on the 'Layout' display, either one or two measurement variables can be displayed.

15.4.5 Menu timeout (parameter M_OUT)

The menu timeout time defines the time after which the menu function is automatically exited without a key being pressed. With the setting "0 s" this function is deactivated and the menu function can only be exited manually by pressing the back button (several times).

15.5 Other (main menu MISC)

15.5.1 Zero point adjustment function (OFFSET parameter)

If YES is confirmed, sets the current pressure measurement value as zero point (duration of the calibration function: 5 sec.) This function is not available for devices with an absolute pressure measuring cell.

15.5.2 Reference surface force measured value (AREA parameter)

Reference area in [mm²] with which the measured pressure value P is converted into the measured force value F (see section 11.2)

15.6 Measurement (main menu MEAS)

The measurement variables provided by the transducer are listed under the "MEAS" menu. With the pressure sensor MAN-SC / -LC these are:

- Pressure measurement value (measurement variable 0, submenu "0: P"
- Force measurement value (measurement variable 2, submenu "2: F"

Each measurement variable is still divided into its own submenu. In the submenu, all parameters relating to the respective measurement variables can be adjusted.

15.6.1 Pressure (submenu 0: **_P**) / force (submenu 2: **_F**)

15.6.2 Unit (UNIT parameter)

The displayed unit for the pressure measurement can be selected from various predefined standard units. The definition of a user-specific unit "USR" is also possible. The unit is selected by selecting the unit symbol in the display.

If the USR unit is selected, a factor for the basic unit "bar" must be entered. E.g. unit "USR" = 10 bar, then at 20 bar measured value 2.0 "USR" is shown on the display.

The unit "USR" can be set independently of one another for pressure and force measured values.

15.6.3 Simulation mode (submenu **SIM**)

With the simulation function, all available measured values can be simulated independently of one another for a limited period of time. The simulated measured values have a full effect on the displays and outputs.

Each simulation started is automatically ended after the time set in the "Sim Autostop Time" (user service) parameter (1 to 30 minutes) or after the programmed intervals have elapsed.

The following measured values can be simulated:

Pressure and force

Note: If a simulation is carried out for the measured value pressure, the measured value for the force remains unaffected. The dependency of the force measured value on the pressure measured value is omitted in the simulation.

The simulation starts as soon as the simulation is activated and the setting menu is exited. The simulation is interrupted or stopped if the settings menu is called up in the meantime. There are 3 different types of simulation available for each purpose:

a.) "Static" mode

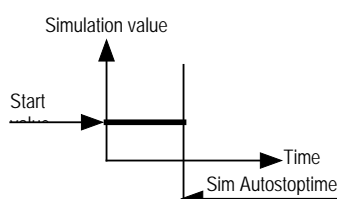

In the "Static" mode, a constant value is output for the measured values pressure and force. The simulation ends after the set simulation time.

b.) „Triangle“ mode

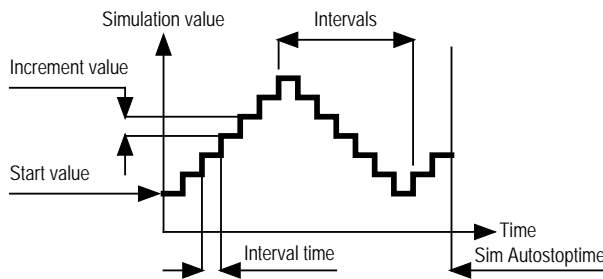

In "Triangle" mode, the simulation value increases continuously in the increment of the parameter "Increment value" and in the interval "Interval time" with the "Start value". After the amount of the parameter "intervals", the simulation value decreases again in the same way, in order to increase again. This process is repeated continuously

until the set time "Sim Auto Stop Time" has expired and the simulation ends.

c.) "Monotonic" mode

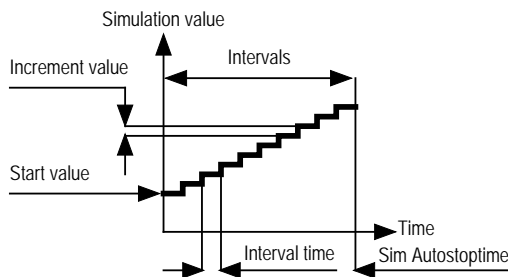

In "Monotonic" mode, the simulation value increases continuously in the step size of the parameter "Increment value" and in the interval "Interval time" with the "Start value". After the amount of "Intervals" or the expiration of "Sim Auto Stop Time", the simulation ends.

15.7 Outputs (main menu OUT1, OUT2, only MAN-LC)

The MAN-LC pressure measuring device provides a total of 2 outputs, most of which are freely configurable. The outputs (output 1 and output 2) are configured using a wizard function. The wizard function guides the user step by step through all the necessary settings.

Steps:

- Select output (select submenu OUT1 or OUT2)
- Selection of the source or the measurement variable to be output (pressure or force)
- Selection of an output type (4-20 mA, 0-20 mA, 0-10 V, 2-10 V, alarm, Frequency output, IO-Link, control input)
- Setting of the output (scaling, thresholds, function)
- Save the configuration

The different output types are optimized for different types of application. The following table contains the application recommendations for the various output types. If the outputs are not used according to the recommendations, measurement deviations may occur and the desired functionality will not be achieved.

Application	Output type		
	Analog output (all variations)	Frequency output	Alarm output
Remote transmission of measured values	✓	✓	
Limit value monitoring			✓
Window surveillance			✓

Configuration of the outputs MAN-LC ...

Output 1 (OUT1, PIN4)	Output 2 (OUT2, PIN 2)
	Analoge output 4-20 mA
	Analoge output 0-20 mA
	Analoge output 2-10 V
	Analoge output 0-10 V
Alarm output NPN/PNP/PP	Alarm output NPN/PNP/PP
Frequency output PP	Frequency output PP
KofiCom communication mode	
Communication mode IO-Link	
Control input	

15.7.1 Alarm output (OUT1 and OUT2)

The alarm outputs can be parameterized with a limit or a window function.

If the alarm function is activated for one or both outputs, corresponding rectangular symbols are shown in the display. If the measured value exceeds the set switching point (with limit function) or if the measured value is outside the defined window (window function), the symbol SP1 or SP2 is displayed in the respective rectangle (see 15.7.1.1).

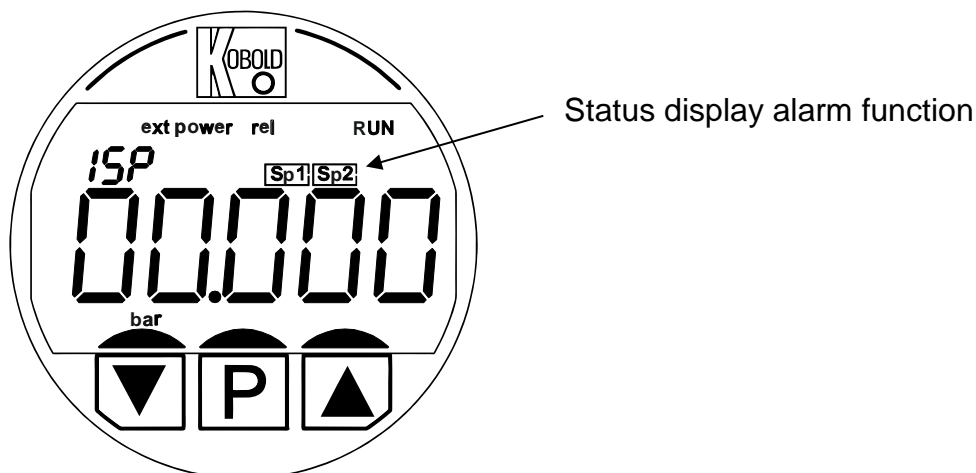

15.7.1.1 Function

The FUNC parameter defines the basic function. Limit functions and window functions are available.

Limit function (parameter LIMIT):

The switching output is active when the current measured flow value is above the switching threshold. It remains active until the measured value has fallen below the switching threshold minus the hysteresis.

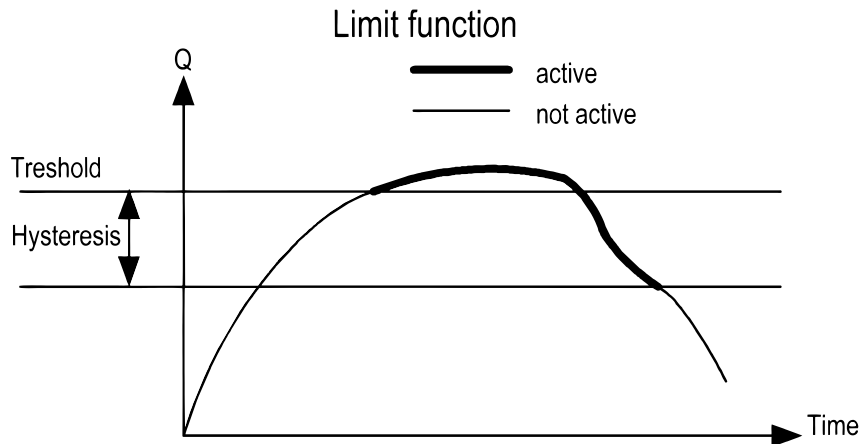

Window function: The switching output is **active** if the current flow measured value is outside a window, which is formed by the "switching threshold" and the "lower threshold". The monitored window decreases in each case by the amount of the "hysteresis". If the switching output is to be **active** within the window, the parameter "switching function" must be changed from N/O to N/C.

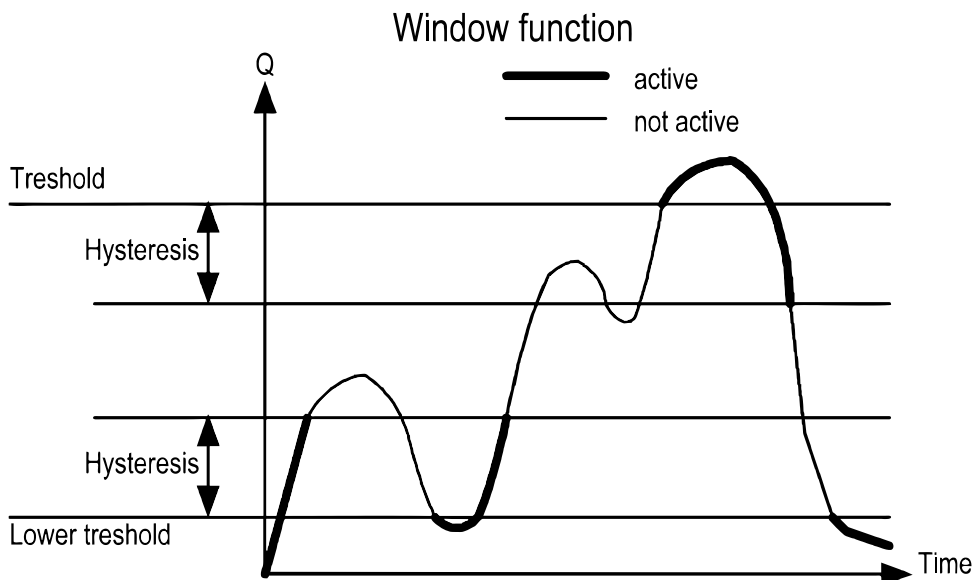

15.7.1.2 Output type (parameter TYPE)

The parameter "*Output type*" defines the function of the transistor output. NPN, PNP or PP (push-pull) output types are available. The push-pull type combines NPN and PNP and is therefore the best choice for most circuits. All outputs are short circuit and overload protected.

15.7.1.3 Switching threshold (parameter SWI)

The "switching function" defines the mode of operation of the outputs. In the standard setting "normally open", the output is activated (switched) when the measured value exceeds the switching threshold. This function is also known as the "normally open function", "open-circuit principle" or "N.O." (normally open). In the "Normally closed" setting, the output is already active below the switching threshold and is deactivated when the measured value exceeds the switching threshold. This function is also referred to as the "normally closed function", closed-circuit principle "or" N.C. "(normally closed).

15.7.1.4 Switching threshold (parameter THRE)

The "Switching threshold" parameter defines the limit value for the limit function and the upper limit for the window function.

15.7.1.5 Lower threshold (LTHRE parameter, only with activated window function)

The "lower switching threshold" defines the lower limit value when using the window function. This parameter remains ineffective when the limit function is used. The switching thresholds can be set both positive and negative.

15.7.1.6 Hysteresis (parameter HYST)

The appropriate setting of the "hysteresis" parameter ensures that the switching outputs do not switch on and off continuously when the current measured value fluctuates around the switching threshold. The hysteresis value should therefore always be greater than the real measured value fluctuations. As a result, a targeted suppression can be achieved.

15.7.1.7 Switching delay (SUPPR parameter)

Further interference suppression of the switching outputs from fluctuating measurement signals can be achieved by setting the SUPPR parameter. If this parameter is selected greater than 0, the switching of the output is delayed accordingly. The parameter SU DI defines whether the delay should take effect when the switching threshold is exceeded or not reached (alternatively in both directions).

"High" means that the delay is active when the measured value exceeds the switching threshold, "Down" means the corresponding effect when the value falls below the switching threshold.

The measured value must continuously exceed or fall below the switching threshold with the value of [SUPPR] before the switching output is activated.

With this function, sporadic exceeding of limit values can be safely suppressed. The response time of the output is generally extended according to the value of the SUPPR parameter.

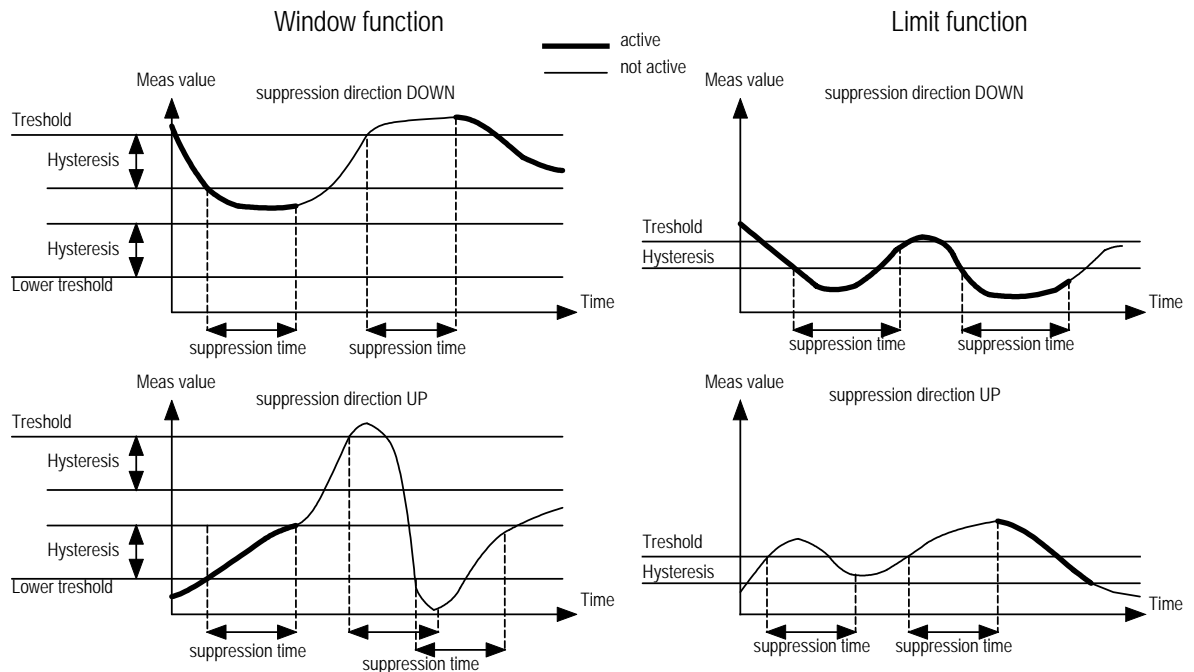

Examples of the effect of the switching delay for window and limit function

15.7.2 Analogue outputs

15.7.2.1 Current output 0-20 mA / 4-20 mA

The current output is a measurement variable (pressure or force) in scaled form as a 0-20 mA or 4-20 mA current signal.

The current output is scaled using the parameters "Value 20 mA" and "Value 0 mA" or "Value 4 mA". The "Value 20 mA" parameter is set to the value for the end of the measuring range by default, but can be parameterized anywhere within the measuring range, but this must always be greater than the start of the measuring range.

The parameters "Value 0 mA" and "Value 4 mA" define the measured values for the starting current value. These can also be freely set in the measuring range.

Note 1: If the "Value 20 mA" parameter is set smaller than the end of the measuring range, the accuracy of the output current value is reduced.

Note 2: The load for the current output must not be greater than 500 Ω.

15.7.2.2 Voltage output 0-10 V / 2-10 V

The voltage output is a measurement variable (pressure or force) in scaled form as a 0-10 V / 2-10 V voltage signal.

The voltage output is scaled using the parameters "Value 10 V" and "Value 0 V" or "Value 2 V". The "Value 10 V" parameter is set to the value for the end of the measuring range by default, but can be parameterized anywhere within the measuring range, but must always be greater than the start of the measuring range. The parameters "Value 0 V" and "Value 2 V" define the measured values for the starting voltage value. These can also be freely set in the measuring range.

Note 1: If the value is set smaller than the end of the measuring range, the accuracy of the voltage value output is reduced.

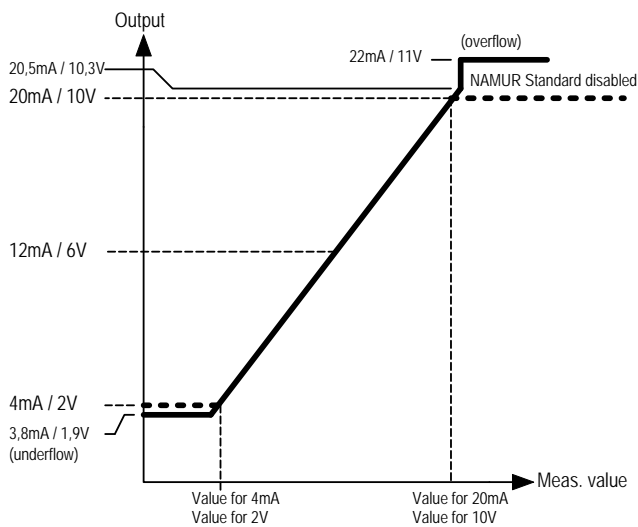

Output behavior 4-20 mA and 2-10 V

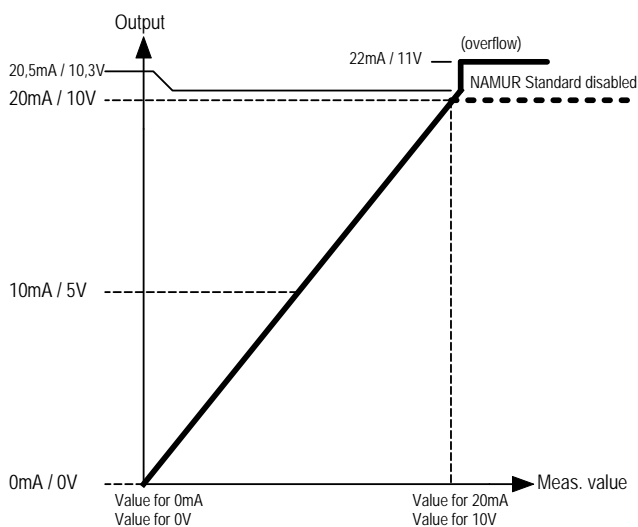

Output behaviour 0-20 mA and 0-10 V

15.7.2.3 Activation of behaviour according to NAMUR recommendation NE43

For all analogue outputs (current and voltage), the output behaviour can be activated according to NAMUR recommendation NE43. When the function is activated, e.g. the linear output of the 4 to 20 mA signals to 3.8 to 20.5 mA. Above 20.5 mA, the current value jumps to approx. 22 mA to signalise a measuring range overshoot. Current output values between 3.8 and 4.0 mA indicate that the measuring range is undershot. The output of approximately 3.6 mA signals a device or process fault.

15.7.3 Frequency output (OUT1 and OUT2)

The MAN-LC provides a scalable frequency output. If this output is activated, the measurement variable (pressure or force) assigned to the frequency output is output proportionally as a frequency with a 1: 1 pulse / pause duration. The output frequency at the end of the measuring range can be set (parameter "max. Frequency"). With the two parameters "Value at 0 Hz" and "Value at max Hz", the frequency output can be freely scaled in the measuring range.

Behavior on OVERFLOW:

If the measured value is in the overflow range, a constant frequency is output.

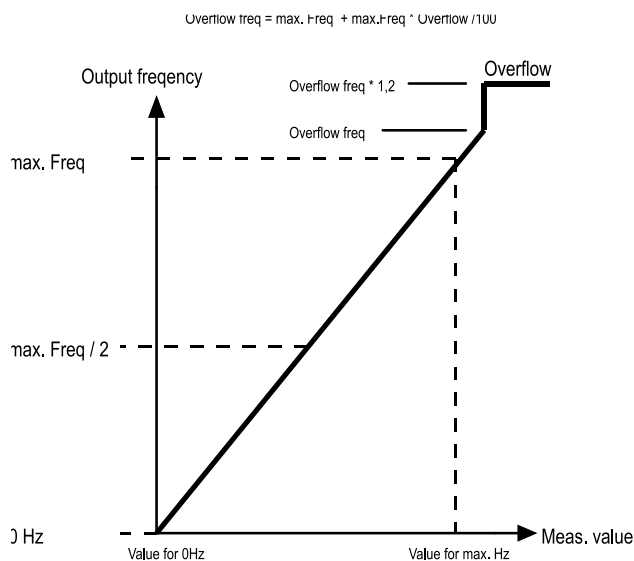

Output behavior Frequency output

15.7.4 KofiCom (parameter KOFIC, OUT1)

KofiCom is an in-house communication standard for service purposes. This function is only available for factory service.

15.7.5 IO-Link (parameter IOLIK, OUT1)

If OUT1 is set to IOLIK, the IO-Link functionality can be used via this output.

15.7.6 Control input (parameters CTLIN, OUT1)

Output 1 can be configured as a control input. This can be used to reset the MIN / MAX memory, depending on the assigned measurement variable.

If output 1 is parameterized as a control input, the saved MIN / MAX values can be reset to the current measured value with the aid of an externally applied active control signal. There is no internal pull-up resistor, so an active LOW / HIGH signal must be applied. The control input must not be left open!

HIGH threshold: $15 V_{DC} \leq U_{High} \leq V_s$
 LOW threshold: $0 \leq U_{Low} \leq 10 V_{DC} \leq$

Function	Measured value	Control pulse duration
MIN/MAX Reset	Pressure, force	$0.5s < t_{high} < 4s$

15.8 User service (main menu USER)

A reset function and password setting are available to the user in the user service. Together with the activation of a user password, menu access for the user can therefore be blocked by a master user.

15.8.1 User password (PASSWORD parameter)

In the factory setting, the user password is set to "00000", which means that the user functions are freely accessible. If the user password is set differently from "00000", the password query will be activated the next time you enter the user menu. If the set password is no longer known, a master password can be requested from KOBOLD.

15.8.2 Factory reset (FACTS parameter)

By activating this function, the user can reset the device to the factory settings. Any user settings will then be lost and the device will be in the delivery state again.

15.8.3 Menu lock (LOCK parameter)

With this function the user can activate the password query when entering the menu. If the "LOCK" setting is selected, the settings menu can only be accessed by entering the password that is defined in "PASSW".

15.8.4 Simulation timeout (SAS parameter)

Specifies the time in minutes after which the simulation is automatically ended.

15.9 Factory service (main menu FACT)

Access is only intended for authorized persons and is password-protected.

15.10 Info (main menu INFO)

General (parameter GEN)

The device type is displayed in this info option

Version (parameter VER)

The firmware version of the device is displayed in this info option

Firmware revision (parameter REV)

The firmware revision of the device is displayed in this info option

16. Maintenance

If the medium to be measured is not contaminated, the device is maintenance-free.

16.1 Notice According to the Battery Law

Old batteries do not belong in municipal waste. You can send the batteries back to us or an authorized address, free of charge. As consumer, you are legally obliged to return the used batteries.

Hazardous batteries are provided with a mark consisting of a crossed-out trash and the chemical symbol (Cd, Hg, Li or Pb) of heavy metal for classification as respective contaminant:

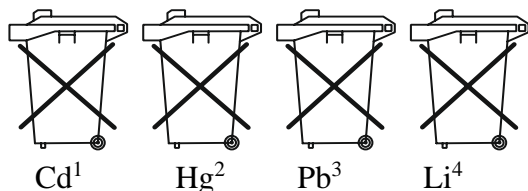

1. "Cd" stands for cadmium.
2. "Hg" stands for mercury.
3. "Pb" stands for lead.
4. "Li" stands for lithium.

17. Technical Data

General

Display:	5-digit LC-display (MAN-LC with white backlight) Digit height 16 mm
Measuring range:	-1...0...+1600 bar (special measuring ranges on request)
Accuracy class:	0.5 at 21 °C
Temperature influence:	±0.25% of full scale/10 K
Temperature coefficient:	Zero point ≤ ± 0.2 % of full scale/10 K Range ≤ ± 0.1 % of full scale/10 K
Zero point correction:	≤ ± 25 % of full scale
Overload area:	3 x PN (up to 40 bar) 2 x PN (60 to 160 bar) 1.5 x PN (250 to 1600 bar)
Conversion rate internal:	10 per second
Display and outputs refresh:	1 ... 10 s

Supply voltage

MAN-LC	External supply 18 – 32 VDC via M12x1 connector Current consumption max. 200 mA (without outputs)
MAN-SC	Battery 6LR01 (nominal voltage 9V)

Battery lifespan

Battery type 6LR61 (9V)	Lifespan (typical at 20°C)
Alkaline 600 mAh	Up to 9.000 h (~ 1 year)*
Lithium 1300 mAh	Up to 22.500 h (~2.5 years)*

The open circuit voltage of the batteries used (alkali or lithium) may not exceed 10 VDC, higher open circuit voltages destroy the electronics!

*: Self battery-discharging not considered. The battery capacity reduces with low ambient temperature.

Electrical outputs (MAN-LC)

Frequency output (OUT1/OUT2):	Push-pull, free scalable
Alarm output (OUT1/OUT2):	NPN, PNP, Push-Pull configurable max. 30 VDC, max. 200 mA short-circuit proof
Analogue output (OUT2):	active, 3-wire 0(4)-20 mA max. load 500 Ω or 0(2)-10 V _{DC} , (R _{Load} ≥ 50 kΩ, load error ≤ 1%)

MAN-SC/-LC

Control input (OUT1)	MIN/MAX RESET OUT1, High active $0 < U_{Low} < 10 V_{DC}$ $15 V_{DC} < U_{High} < V_S$
IO-Link (OUT1):	Manufacturer ID: 1105 (decimal), 0x0451 (hex) Name of manufacturer: Kobold Messring GmbH IO-Link Specification: V1.1 Bitrate: COM2 Minimal cycle time: 10 ms SIO-Mode: yes (OUT1 in configuration IO-Link) Block parameterisation: yes Operational readiness: 10 s Max. cable length: 20m

Housing: Ø 80 mm, PA6 GK30, front display polycarbonate

Wetted parts

Sensor:	ceramic (Al ₂ O ₃) (meas. range ≤ 700 bar) Stainless steel (1.4571) (meas. range >700 bar)
Gasket:	NBR (meas. range ≤ 700 bar), (other materials on request)
Process connection (selectable):	G 1/4, G 1/2, 1/4 NPT, 1/2 NPT AG Meas. range ≥ 1000 bar only G 1/2 stainless steel 1.4571 (other connections on request)
Medium temperature:	-30...+85 °C
Ambient temperature:	0...+60 °C
Storage temperature:	-30...+80 °C
Allowed relative humidity:	< 90 %, non-condensing
Protection class:	IP65
Elektrical connection:	round conector M12x1
Weight:	MAN-SC: approx. 360 g MAN-LC: approx. 310 g (weights of other process connections deviate)

18. Device delivery status

Device type		Parameter	Value	Comment
MAN-SC	MAN-LC			
X	X	Display layout	Single => Pressure reading	
X	X	Display refresh	1 s	
-	X	Output 1	IO-Link	
-	X	Output 2	deactivated	
X	X	Pressure measuring unit	Bar	
X	X	Force measuring unit	N	

19. Order codes

(Example: MAN-SC10G2A3000)

Model	Output	Mechanical connection	Measuring range ¹⁾	Electrical connection	Sensor gasket	Special version
MAN-SC (digital manometer with ceramic sensor 9 V)	10 = without		AC = -0,6...0 bar AD = -1...0 bar A0 = -1...+0,6 bar A1 = -1...+1,5 bar A2 = -1...+3 bar A3 = -1...+5 bar A4 = -1...+9 bar A5 = -1...+15 bar B1 = 0...+0,6 bar B2 = 0...+1 bar B3 = 0...+1,6 bar B4 = 0...+2,5 bar B5 = 0...+4 bar B6 = 0...+6 bar B7 = 0...+10 bar B8 = 0...+16 bar B9 = 0...+25 bar B0 = 0...+40 bar C1 = 0...+60 bar C2 = 0...+100 bar C3 = 0...+160 bar C9⁴⁾ = 0...+200 bar C4 = 0...+250 bar C5 = 0...+400 bar C6 = 0...+600 bar C0⁴⁾ = 0...700 bar D7²⁾ = 0...1000 bar D8²⁾ = 0...1600 bar EC = -10...0 psi ED = -30...0 inHg/PSIG E0 = -30...+15 inHg/PSIG E1 = -30...+30 inHg/PSIG E2 = -30...+60 inHg/PSIG E3 = -30...+100 inHg/PSIG E4 = -30...+150 inHg/PSIG F1 = 0...+10 psi F2 = 0...+15 psi F3 = 0...+30 psi F4 = 0...+50 psi F5 = 0...+60 psi F6 = 0...+100 psi F7 = 0...+150 psi F8 = 0...+200 psi F9 = 0...+300 psi F0 = 0...+500 psi G1 = 0...+1000 psi G2 = 0...+1450 psi G3 = 0...+2000 psi G4 = 0...+2300 psi G5 = 0...+3000 psi G6 = 0...+3600 psi G7 = 0...+5000 psi G8 = 0...+5800 psi G9 = 0...+7500 psi G0 = 0...+10 000 psi H1²⁾ = 0...+15 000 psi H2²⁾ = 0...+20 000 psi	0 = without		
MAN-LC (digital manometer with backlight, 18-32 VDC supply)	30 = with 2 configurable outputs (OUT1, OUT2)	Meas. range -1...+1600 bar: G2 = G ¼ male G4 = G ½ male N2 = ¼" NPT male N4 = ½" NPT male Meas. range up to 700 bar: K2 = Connection bottom G ¼ male with cooling fins K4 = Connection bottom G ½ male with cooling fins C2 = Connection bottom ¼" NPT with cooling fins C4 = Connection bottom ½" NPT with cooling fins M1 = Connection bottom M16 x 1.5 male M2 = Connection bottom M20 x1.5 male M6 = Connection M6 female with O-ring groove U7 = Connection bottom 7/16-20 UNF DIN 3866 D2 = Connection bottom G ¼ male DIN 3852-E + FPM gasket YY = on request DM³⁾ = Assembly with diaphragm seal		S = M12 x 1 connector	0 = NBR (standard, from 700 bar fully welded without gasket) 1 = FKM 2 = EPDM 3 = FFKM	0 = without Y = special (please specify in writing)

¹⁾ Custom selectable measuring units: kPa, bar, mbar, psi, kN, N, torr, inWC, mmWC, inHg, USR



²⁾ Measuring range ≥ 1000 bar only with G ½ male

³⁾ Diaphragm seal model and application data to be specified in clear text. Application Index on the last two pages of the data sheet to be filled out, or discuss with your local KOBOLD technical sales office. For a summary of diaphragm seal models and possible ranges, see page 11 and following. For dimensional details consult our DRM data sheet at www.kobold.com.

In case of ordering a remote diaphragm seal with capillary and for mounting with wall mounting bracket MZB-709... acc. to DIN 16286, an additional ordering of the adaptor model MZB-708/... acc. to DIN 16281 for factory sided integration in diaphragm seal assembly is mandatory.

⁴⁾ Measuring range for hydraulic applications

Accessories for standard versions

Order code	Description	Image
ZUB-MANS-KON1*	Pluggable retrofit kit with 2x potential-free SPDT contact, comprising of a relay board and 2 x socket head cap screws M2x16 (only for MAN-LC...) Switching capacity per contact: 30 VAC/DC, max. 1 A	
ZUB-MANS-KON2*	Pluggable retrofit kit with 2x potential-free SPDT contact, comprising of a relay board and 2 x socket head cap screws M2x16 and 8-pin M12 connector (only for MAN-LC...) Switching capacity per contact: 30 VAC/DC, max. 1 A	
ZUB-MANS-KAP01	Rubber protection sleeve MAN-SC/LC	

*: The separate operating instructions must be observed when installing and commissioning the relay retrofit kits

20. Dimensions

MAN-SC

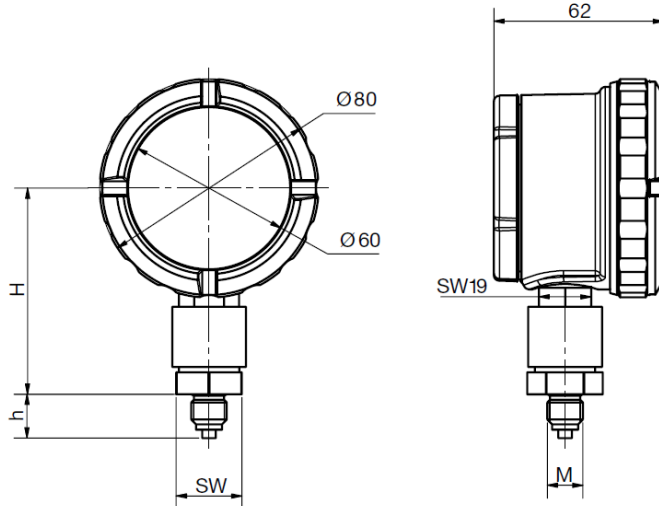

MAN-LC

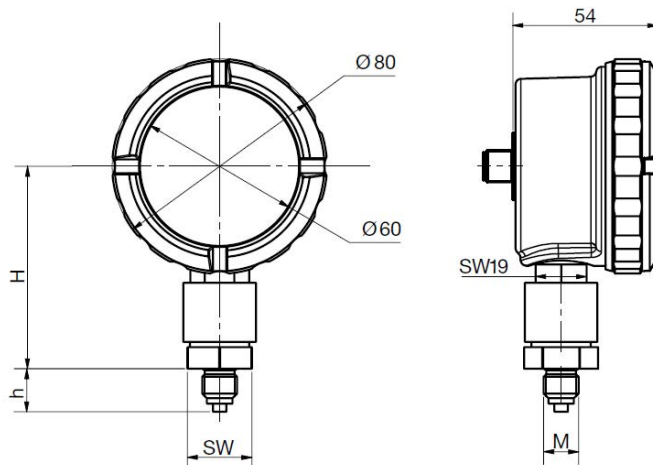

Mechanical connection	Code	M	SW [mm]	H ^{+2 mm} [mm]*	h [mm]
G ¼ male	G2	G ¼ male	24	75	16.5
G ½ male	G4	G ½ male	24	75	25.5
¼" NPT male	N2	¼" NPT	24	75	14.5
½" NPT male	N4	½" NPT	24	75	19
G ¼ male *** 1000 + 1600 bar / 15+20 k PSI	G2	G ¼ male	27	83	16.5
G ½ male *** 1000 + 1600 bar / 15+20 k PSI	G4	G ½ male	27	83	25.5
¼" NPT male *** 1000 + 1600 bar / 15+20 k PSI	N2	¼" NPT	27	83	14.5
½" NPT male *** 1000 + 1600 bar / 15+20 k PSI	N4	½" NPT	27	84	19
Connection bottom G ¼ male with cooling fins ***	K2	G ¼ male	24	94.5	16.5
Connection bottom G ½ male with cooling fins ***	K4	G ½ male	24	94.5	25.5
Connection bottom ¼" NPT with cooling fins ***	C2	¼" NPT	24	94.5	14.5
Connection bottom ½" NPT with cooling fins ***	C4	½" NPT	24	94.5	19
Connection bottom M20x1.5 male	M2	M20x1.5	24	78	23.5
Connection bottom M16x1.5 male	M1	M16x1.5	24	78	23.5
Connection M6 female with O-ring groove	M6	M6 female	24	75	-
⅜ UNF DIN 3866 stainless steel	U7	⅜ UNF	24	75	15
G ¼ male DIN 3852-E stainless steel + FPM gasket	D2	G ¼ male	24	75	12

* The counter nut at the sensor can be loosened by the customer and the electronic housing rotated max. 360°. This changes the height H by approx. +1.75 mm (corresponds to thread slope). This rotation enables any orientation of the unit after final mounting is done.

MAN-SC/-LC

Rubber protection sleeve ZUB-MANS-KAP01 (optional)

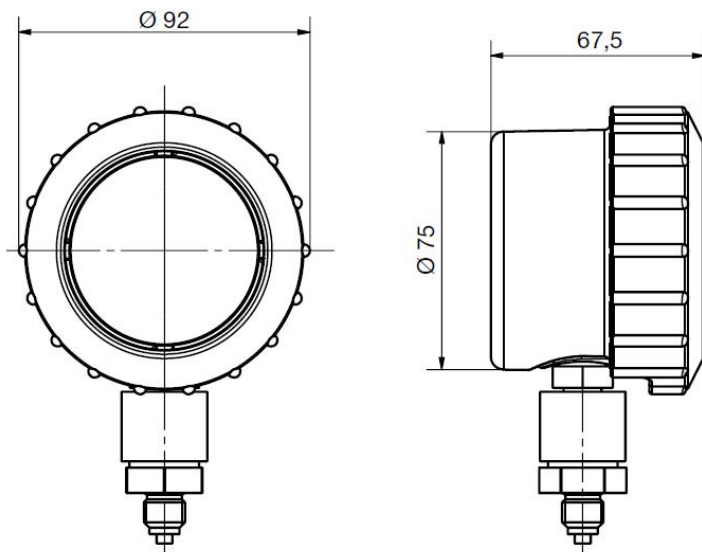

21. IO-Link manufacturer's declaration



MANUFACTURER'S DECLARATION OF CONFORMITY

We:

Kobold Messring GmbH
Nordring 22-24
65719 Hofheim
Germany

declare under our own responsibility that the product(s):

MAN-LC*** (IO-Link Device)**

to which this declaration refers conform to:

- IO-Link Interface and System Specification, V1.1, July 2013 (NOTE 1,2)
- IO Device Description, V1.1, August 2011
- IO-Link Interface and System Specification, V1.0, January 2009 (NOTE 1)
- IO Device Description, V1.0.1, March 2010
-

The conformity tests are documented in the test report:

IO-Link_Device_TestReport_MAN-LC_20190704.pdf

Issued at Hofheim, 01.06.2020

Harald Peters
General Manager

Manfred Wenzel
Proxy Holder

Reproduction and all distribution without written authorization prohibited

NOTE 1 Relevant Test specification is V1.1, July 2014

NOTE 2 Additional validity in Corrigendum Package 2015

22. EU Declaration of Conformity

We, KOBOLD Messring GmbH, Hofheim-Ts, Germany, declare under our sole responsibility that the product:

Digital Pressure Gauge

Model: MAN-SC/-LC

to which this declaration relates is in conformity with the standards noted below:

EN IEC 63000:2018 Technical documentation for the assessment of electrical and electronic products with respect to the restriction of hazardous substances

EN 61326-1:2013

Electrical equipment for measurement, control and laboratory use - EMC requirements - Part 1: General requirements

Also, the following EC guidelines are fulfilled:

2014/30/EU

EMC Directive

2011/65/EU

RoHS (category 9)

2015/863/EU

Delegated Directive (RoHS III)

2012/19/EG

WEEE

Only for MAN-SC:

2006/66/EG

Directive Batteries and Accumulators

Hofheim, 20 May 2021



H. Volz
General Manager

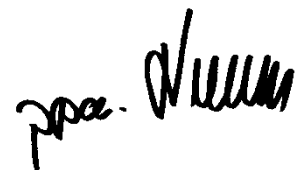

M. Wenzel
Proxy Holder

1. Appendix IO-Link specification MAN-LC

1.1 IO-Link process data structure

Process data length: 4 Bytes (32 Bit)

Bit number	Data	Bit counter	Format	Factor	Range	Unit
0 - 29	Pressure	30 Bit	IntegerT	1/100000	± 5368,70912	Bar
29 - 30	Status OUT1	1 Bit	BooleanT			
30 - 31	Status OUT2	1 Bit	BooleanT			

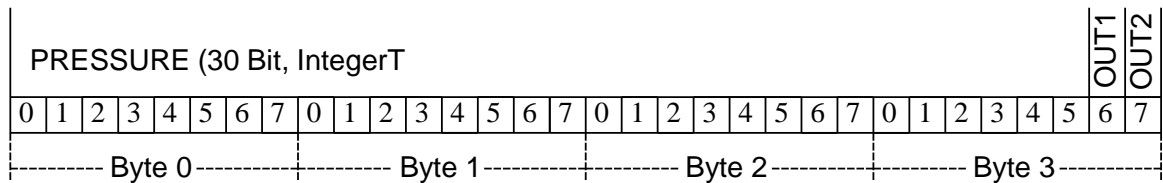

1.2 IO-Link diagnostic information

Event Code [hex]	Event Code [dec]	Name	Device Status	Type	Definition
0x7710	30480	Short Circuit		Error	check installation
0x8C10	35856	Process Variable Range Overrun		Warning	process data uncertain
0x8C20	35872	Measurement Range Overrun		Error	check application
0x8C30	35888	Process Variable Range Underrun		Warning	process data uncertain
0x1838	6200	1. Test Event For Protocol Testing		Error	first test event
0x1839	6201	2. Test Event For Protocol Testing		Error	secont test event
0x183A	6202	Pressure MRE Overrun	2	Warning	pressure measuring range overrun
0x183B	6203	Pressure MRS Underrun	2	Warning	pressure measuring range underrun
0x183C	6204	Pressure Overflow Overrun	2	Warning	pressure overflow range overrun
0x183D	6205	Pressure Underflow Underrun	2	Warning	pressure underflow range underrun
0x1842	6210	Pressure Sensor Error	4	Error	no pressure sensor attached
0x1844	6212	Measuring Circuit Saturated	2	Warning	ADC out of range
0x1845	6213	Simulation Active	0	Warning	indicades that one of the simulations is running

MAN-SC/-LC

1.3 IO-Link system command table

Command (hex)	Command (dec)	Command name
0x82	130	Restore Factory Settings
0xA0	160	Set Pressure Offset
0xA1	161	Start Pressure Simulation
0xA2	162	Stop Pressure Simulation
0xA5	165	Start Force Simulation
0xA6	166	Stop Force Simulation
0xA7	167	Events Handling ON
0xA8	168	Events Handling OFF
0xA9	169	Reset MinMax for Pressure

1.4 IO-Link ISDU parameter table

Index [hex]	Object Name	Description	Factory Default Value	Max Value	Min Value	Length (Bytes)	Data Type	Access
SYSTEM								
0x0002	SystemCommand	See Table "Comand Codes"				1	UIntegerT	W
PRODUCT IDENTIFICATION								
0x0010	VendorName	only read parameter	Kobold Messring			max. 20	StringT	R
0x0011	VendorText	only read parameter	www.kobold.com			max. 32	StringT	R
0x0012	ProductName	only read parameter	MAN-LC			max. 16	StringT	R
0x0013	ProductID	only read parameter	MAN-LC			max. 16	StringT	R
0x0014	ProductText	only read parameter	pressure sensor			max. 32	StringT	R
0x0015	SerialNumber	only read parameter				max. 8	StringT	R
0x0016	HardwareRevision	only read parameter				max. 8	StringT	R
0x0017	FirmwareRevision	only read parameter				max. 8	StringT	R
0x0018	ApplicationDevice Tag	tag name (user configurable)				32	StringT	R/W
0x0019	FunctionTag	function tag (user configurable)				32	StringT	R/W
0x0020	LocationTag	location tag (user configurable)				32	StringT	R/W
Device Status Information								
0x0024	DeviceStatus	device status		(0) - Device OK (1) - Maintenance required (2) - Out of specification (3) - Functional check (4) - Failure		1	UIntegerT	R
0x0025	DetaildDevice Status	detaild device status				max. 20	ArrayT of OctetStrin	R

MAN-SC/LC

Index [hex]	Object Name	Description	Factory Default Value	Max Value	Min Value	Length (Bytes)	Data Type	Access
							gT3	
DISPLAY CONFIGURATION								
0x0102	DisplayLayout	Single or alternating	0	(0) - single (1) - alternating		1	UIntegerT	R/W
0x0103	FirstDisplay	Source for the first display	0	(0) - Pressure (2) - Force		1	UIntegerT	R/W
0x0104	SecondDisplay	Source for the second display	2	(0) - Pressure (2) - Force		1	UIntegerT	R/W
0x0105	DisplayRefresh Time	Refresh intervall for the display [s]	1,0	10,0	1	4	FloatT	R/W
0x0109	Automatic MenuLeave	Automatic menu leave if the timeout [s] is hit. (0) - not active	0	60	0	1	UIntegerT	R/W
OUTPUT 1								
0x010C	OUT1Alarm Function	Limit or window function for the alarm output	0	(0) - Limit (1) - Window		1	UIntegerT	R/W
0x010D	OUT1Alarm OutputType	Alarm output NPN, PNP or Pushpull	0	(0) - NPN (1) - PNP (2) - PushPull		1	UIntegerT	R/W
0x010E	OUT1Alarm SwitchFunction	Alarm output normally opened or closed	0	(0) - normally opened (1) - normally closed		1	UIntegerT	R/W
0x010F	OUT1Alarm Threshold	Threshold for the alarmoutput	1,0	MRE	MRS	4	FloatT	R/W
0x0113	OUT1Alarm LowerThreshold	Threshold for the alarmoutput used by the windowfunction	1,0	OUT1 Alarm-Threshold	MRS	4	FloatT	R/W
0x0117	OUT1Alarm Hysteresis	Switching hysteresis for the alarmoutput	1,0	9999,0	-9999,0	4	FloatT	R/W
0x011B	OUT1Alarm SuppressionFactor	How many times the threshold must be hit in order to switch the alarm output	0	60	0	1	UIntegerT	R/W
0x011C	OUT1Alarm Suppression Direction	for which direction the suppression factor is used	0	(0) - Up (1) - Down (2) - Both		1	UIntegerT	R/W
0x0155	OUT1Frequencyat FS	Max. frequency in Hz for the output	500	1000	50	2	UIntegerT	R/W
0x0157	OUT1FrequencyOverflow	Overflow frequency in percent of the max frequency	1	100	0	1	UIntegerT	R/W
0x0158	OUT1FrequencyValue0Hz	Value from source used for 0 Hz scaling point	0,0	OUT1-Frequency - ValueMax Hz	MRS	4	FloatT	R/W
0x015C	OUT1FrequencyValueMaxHz	Value from source used for max. Hz scaling point	100,0	MRE	OUT1-Frequency - Value0Hz	4	FloatT	R/W
0x0160	OUT1CtrlFunction	Controlinputfunction	0	(0) - Off (1) - Memory Reset		1	UIntegerT	R/W
OUTPUT 2								
0x0171	OUT2Source	Source for the	0	(0) - Pressure		1	UIntegerT	R/W

MAN-SC/-LC

Index [hex]	Object Name	Description	Factory Default Value	Max Value	Min Value	Length (Bytes)	Data Type	Access
		output		(2) - Force				
0x0172	OUT2Type	Configuration of the output	0	(0) - disabled (1) - Alarm Output (2) - 4-20mA (3) - 0-20mA (4) - 2-10V (5) - 0-10V (7) - Frequency Output		1	UIntegerT	R/W
0x0173	OUT2AlarmFunction	Limit or window function for the alarm output	0	(0) - Limit (1) - Window		1	UIntegerT	R/W
0x0174	OUT2AlarmOutput Type	Alarmoutput NPN, PNP or Pushpull	0	(0) - NPN (1) - PNP (2) - PushPull		1	UIntegerT	R/W
0x0175	OUT2AlarmSwitch Function	Alarmoutput normally opened or closed	0	(0) - normaly opened (1) - normaly closed		1	UIntegerT	R/W
0x0176	OUT2AlarmThreshold	Threshold for the alarmoutput	1,0	MRE	MRS	4	FloatT	R/W
0x017A	OUT2AlarmLower Threshold	Threshold for the alarmoutput used by the windowfunction	1,0	OUT2-Alarm-Threshold	MRS	4	FloatT	R/W
0x017E	OUT2AlarmHysteresis	Switching hysteresis for the alarmoutput	1,0	9999,0	-9999,0	4	FloatT	R/W
0x0182	OUT2AlarmSuppressionFactor	How many times the threshold must be hit in order to switch the alarm output	0	60	0	1	UIntegerT	R/W
0x0183	OUT2AlarmSuppressionDirection	for which direction the suppression factor is used	0	(0) - Up (1) - Down (2) - Both		1	UIntegerT	R/W
0x0185	OUT2AnalogNamurStandard	If enabled (1) the analog output conforms with the NAMUR standard NE42	1	(0) - NAMUR disabled (1) - NAMUR enabled		1	UIntegerT	R/W
0x0186	OUT2AnalogValue0mA	The value from the slot used for the 0mA scaling point	0,0	OUT2AnalogValue20mA	MRS	4	FloatT	R/W
0x018A	OUT2AnalogValue4mA	The value from the slot used for the 4mA scaling point	0,0	OUT2AnalogValue20mA	MRS	4	FloatT	R/W
0x018E	OUT2AnalogValue20mA	The value from the slot used for the 20mA scaling point	100,0	MRE	OUT2-Analog-Value0mA	4	FloatT	R/W
0x0192	OUT2AnalogValue0V	The value from the slot used for the 0V scaling point	0,0	OUT2-Analog-Value10V	MRS	4	FloatT	R/W
0x0196	OUT2AnalogValue2V	The value from the slot used for the 2V scaling point	0,0	OUT2-Analog-Value10V	MRS	4	FloatT	R/W
0x019A	OUT2AnalogValue10V	The value from the slot used for the 10V scaling point	100,0	MRE	OUT2AnalogValue0V	4	FloatT	R/W
0x01B C	OUT2Frequencyat FS	The max. frequency in Hz for the output	500	1000	50	2	UIntegerT	R/W

MAN-SC/LC

Index [hex]	Object Name	Description	Factory Default Value	Max Value	Min Value	Length (Bytes)	Data Type	Access
0x01BE	OUT2FrequencyOverflow	The overflow frequency in percent of the max frequency	1	100	0	1	UIntegerT	R/W
0x01BF	OUT2Frequency-Value0Hz	The value from the slot used for the 0Hz scaling point	0,0	OUT2-Frequency - ValueMax Hz	MRS	4	FloatT	R/W
0x01C3	OUT2Frequency-ValueMaxHz	The value from the slot used for the max Hz scaling point	100,0	MRE	OUT2-Frequency - Value0Hz	4	FloatT	R/W
SERVICE								
0x01D7	ServiceUser-Password	Password for user service menu and main menu	0	99999	0	4	UIntegerT	R/W
0x01DB	ServiceUserMenuLocked	Whether main menu is locked or not	0	(0) - not locked (1) - locked		1	UIntegerT	R/W
0x01DC	Simulation-AutoStop	Auto stop for Simulation after time in minutes	10	31	1	1	UIntegerT	R/W
MISC								
0x01D8	OperatingHoursCounter	Operating hours counter	0	4294967296	0	4	UIntegerT	R
PRESSURE								
0x04ED	Unit	Unit used for pressure	1	(0) - USER (1) - bar (2) - mbar (3) - Pa (4) - kPa (5) - MPa (6) - psi (7) - Torr (8) - inHg (9) - mmWC (10) - inWC		1	UIntegerT	R/W
0x04EE	UserUnit	User Unit used for pressure	1,0	9999,9	0,0	4	FloatT	R/W
0x0506	SimMode	Mode of the Simulation	0	(0) - Static (1) - Triangle (2) - Monotonic		1	UIntegerT	R/W
0x0507	SimStartValue	Value to start with the simulation	0,0	9999,0	-9999,0	4	FloatT	R/W
0x050B	SimIncrement-Value	Incrementation value of the simulation	10,0	999,0	-999,0	4	FloatT	R/W
0x050F	SimNumber-Intervals	Number of intervals to simulation	20	65000	1	2	UIntegerT	R/W
0x0511	SimTimingIntervals	Timinig in ms between intervals	50	50000	10	2	UIntegerT	R/W
0x0513	ValueInSiUnit	Pressure value in SI unit [bar]	0,0	999999,0	-999999,0	4	FloatT	R
0x0517	MinValueInSiUnit	Pressure min value in SI unit [bar]	0,0	999999,0	-999999,0	4	FloatT	R
0x051B	MaxValueInSiUnit	Pressure max value in SI unit [bar]	0,0	999999,0	-999999,0	4	FloatT	R

MAN-SC/-LC

Index [hex]	Object Name	Description	Factory Default Value	Max Value	Min Value	Length (Bytes)	Data Type	Access
Force								
0x05B5	Unit	Unit used for force	1	(0) - USER (1) - N (2) - kN		1	UIntegerT	R/W
0x05B6	UserUnit	User Unit used for force	1,0	9999,9	0,0	4	FloatT	R/W
0x05CE	SimMode	Mode of the Simulation	0	(0) - Static (1) - Triangle (2) - Monotonic		1	UIntegerT	R/W
0x05CF	SimStartValue	Value to start with the simulation	0,0	9999,0	-9999,0	4	FloatT	R/W
0x05D3	SimIncrement-Value	Incrementation value of the simulation	10,0	999,0	-999,0	4	FloatT	R/W
0x05D7	SimNumber-Intervals	Number of intervals to simulation	20	65000	1	2	UIntegerT	R/W
0x05D9	SimTimingIntervals	Timinig [ms] between intervals	50	50000	10	2	UIntegerT	R/W
0x05DB	ValueInSiUnit	Force value in SI unit [N]	0,0	999999,0	-999999,0	4	FloatT	R
0x05DF	MinValueInSiUnit	Force min value in SI unit [N]	0,0	999999,0	-999999,0	4	FloatT	R
0x05E3	MaxValueInSiUnit	Force max value in SI unit [N]	0,0	999999,0	-999999,0	4	FloatT	R

Legend

MRE Measuring Range End

MRS Measuring Range Start