

Digital Pressure Gauge

Battery Powered or IO-Link



measuring
•
monitoring
•
analyzing

MAN-SC/-LC



Display rotatable in 90° increments



Housing rotatable 360°



With optional rubber protection sleeve



IO-Link



- 5-Digit LCD Display
- Capacitive Touchpads
- Peak Memory
- Analog Output, Frequency Output, Switch Output (MAN-LC)
- IO-Link Function (MAN-LC)
- Up to 2 Relays Possible (MAN-LC)
- Selectable Measuring Units
- Tare Function
- Stainless Steel Process Connection
- Assembly with Numerous Diaphragm Seals Possible
- Optional Rubber Protection Sleeve for Rugged Operating Conditions
- MAN-SC: Power Supply via 9V Battery
- Battery Life: up to 2½ Years
- MAN-LC: External Power Supply via 24V_{DC}



KOBOLD companies worldwide:

AUSTRALIA, AUSTRIA, BELGIUM, BULGARIA, CANADA, CHINA, CZECHIA, FRANCE, GERMANY, GREAT BRITAIN, HUNGARY, INDIA, INDONESIA, ITALY, MALAYSIA, MEXICO, NETHERLANDS, PERU, POLAND, REPUBLIC OF KOREA, RUSSIA, SPAIN, SWITZERLAND, THAILAND, TUNISIA, TURKEY, USA, VIETNAM

KOBOLD Instruments, Inc.
1801 Parkway View Drive
Pittsburgh, PA 15205
Main Office:
1.800.998.1020
1.412.788.4890
info@koboldusa.com
www.koboldusa.com



Digital Pressure Gauge Model MAN-SC/-LC

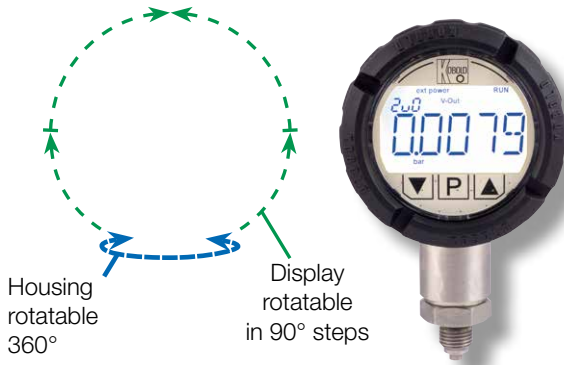

Description

The intelligent KOBOLD digital pressure gauges are used for the display, switching, and remote transmission of pressure-dependent operating sequences in machines and installations. The pressure is sensed by a ceramic or metal sensor and displayed by the electronics. With the MAN-LC version, two universally configurable signal outputs are available. Instead of outputs, the optionally available relay board may drive up to two potential-free relays. The values are shown on a five-digit LCD display. The electronics module can be rotated at 90° increments. In the pressure switch design with an integrated relay, the switching point and hysteresis can be set on the membrane keypad. A wide range of process connections are available. The gauge housing can be axially rotated as desired, after loosening the counter nut.

Examples of Application

- Mechanical Engineering and Plant Construction
- Pumps and Compressors
- Environmental Technology
- Hydraulics and Pneumatics
- Service Jobs
- Process Industry
- Load Capacity Measuring (e. g. Tensile Load Measurement with Pull Tester)

Technical Details

General

Display: 5-digit alpha-numeric reflective LC-display, 14-segment
 » better visibility under direct sunlight and low ambient light «
 (MAN-LC with white backlight and transreflective display)
 Digit height 16 mm
 Shows Primary Value (pressure "P") and Secondary Value (Force "F")
 continuous or alternating (Interval time: 5 s).
 Display Menu Level 3-digit, 7-segment, digit height 4.5 mm

Program Buttons: capacitive (touchpads)

Housing: Ø 80 mm, PA6 GK30, front display polycarbonate

Measuring Ranges: -14.5...0...23,200 PSI
 (special measuring ranges on request)

Accuracy Class¹⁾: 0.5 at reference conditions²⁾ ±1 digit

¹⁾ Including non-linearity, hysteresis, zero-point and end-value deviation (corresponds to measured error per IEC 61298-2).

²⁾ Reference conditions:
 temperature 70 °F, air pressure 860... 1060 mbar, humidity <90 % r. F. (non-condensing)

Temperature Error at -4...185 °F:

Temperature Influence (Overall):

±0.25 % of full scale / 10 K

Temperature Coefficient:

Zero-point ≤ ±0.2 % of full scale / 10 K
 Range ≤ ±0.1 % of full scale / 10 K

Long Term Stability: ≤ ±0.2 % of full scale / year at reference conditions

Adjustability of Zero-point:

≤ ±100 % of full scale (via Tare function)

Overload Range:

3 x PN (to 580 PSI)
 2 x PN (870...2,320 PSI)
 1.5 x PN (3,625...23,200 PSI)

Power-up Time:

ca. 5 s

Response Time:

0.5...1 s (with display refresh time 1 s)

Conv. Rate Internal:

10 per second

Display and Outputs Refresh:

1...10 s

Software Functions

Function	MAN-SC	MAN-LC
Min/Max Peak Memory	yes	yes
Sleep Mode (Automatic Power-off)	yes	no
Password Protection	yes	yes
Reset to Factory Setting	yes	yes
Measuring Units (User Selectable)	kPa, MPa, bar, mbar, psi, kN, N, torr, inWC, mmWC, inHg, USR (user-defined measuring unit)	
Force Measurement	yes	yes
Tare Function	yes	yes
Control Input (for MIN-/MAX-Memory Reset)	no	yes

Calculation of Force Value F:

The measured Force Value is calculated from the measured pressure value and a programmable reference area:
 $Force [N] = 10 \times AREA \times Pressure$
 Measured Value
 with AREA = Reference Area in (mm²) and Pressure Measured Value in (bar)

Rubber Protection Sleeve (Optional):

thermoplastic Elastomer, serves as protection against impact



Supply Voltage

MAN-LC external supply 18 – 32V_{DC} via M12x1 connector
current consumption max. 200 mA (without outputs)

MAN-SC battery 6LR61 (nominal voltage 9V)

Battery Status Display: yes, via 4 segments

Sleep Mode: programmable (for maximizing battery life)

Sleep Mode	Description	Power Consumption*	Note
-	-	~55 µA	Normal measuring mode
0	LC-Display is switched off.	~45 µA	Marginal energy saving via display switch-off. Measurement keeps running.
1	LC-Display is switched off and the measurement stopped.	~20 µA	Fast operational readiness after wake-up (1 to 2 s).
2	Unit in deep sleep mode. No measurement	~13 µA	Unit starts fresh after wake-up. Operational readiness after ca. 5 s. Suitable for storage with installed battery.

* Average current consumption with a 9V battery

Battery Lifespan

Battery Type 6LR61 (9V)	Lifespan (Typical at 68°F)
Alkaline 600 mAh	up to 9.000 h (~ 1 year)*
Lithium 1300 mAh	up to 22.500 h (~2.5 years)*

* Self battery-discharging not considered. The battery capacity reduces with low ambient temperatures.

Wetted Parts

Sensor: ceramic (Al₂O₃) (meas. range ≤ 10,000 PSI)
316 Ti SS (meas. range >10,000 PSI)

Gasket/Temperature of Media

Gasket	Measuring Range	Temperature of Media
none, stainless steel welded	> 10,000 PSI	-22...185 °F
NBR (standard)	≤ 10,000 PSI	-22...185 °F
FKM, FFKM (optional)	≤ 10,000 PSI	-22...185 °F
EPDM (optional)	≤ 10,000 PSI	-22...185 °C (275 °F with cooling fin)

Process Connections

Norm	Thread Size
ANSI/ASME B1.20.1	1/4" NPT
	1/2" NPT
EN837	G 1/4B (standard)
	G 1/2B
For other process connections see table "Order Details"	

Ambient Temp.: 14...140 °F
Storage Temp.: -22...176 °F
Allowed Relative Humidity: <90 %, non-condensing

Protection Class

(acc. IEC 60529): IP65

Electrical Conn.: M12x1 round connector (5 or 8-pin)

Electrical Outputs (MAN-LC)

Frequency Output (OUT1/OUT2): Push-pull, max. 1000 Hz, free scalable, linear to Pressure/Force
Accuracy ≤ ±1.5% of Output

Alarm Output (OUT1/OUT2): NPN, PNP, Push-Pull configurable max. 30V_{DC}, max. 200 mA short-circuit proof

Analog Output (OUT2): active, 3-wire, free scalable
0(4) - 20 mA max. load 500 Ω
or
0(2) - 10V_{DC}, (R_{Load} ≥ 50 kΩ, load error ≤ 1%)

Control Input (OUT1): MIN/MAX RESET
OUT1, High active
0 < U_{Low} < 10V_{DC}
15V_{DC} < U_{High} < V_s

IO-Link (OUT1): Manufacturer ID: 1105 (decimal), 0x0451 (hex)
Name of manufacturer: KOBOLD Messring GmbH
IO-Link specification: V1.1
Bit rate: COM2
Minimal cycle time: 10 ms
SIO-Mode: yes (OUT1 in configuration IO-Link)
Block parameterization: yes
Operational readiness: 10 s
Max. cable length: 20 m

Configuration of Outputs MAN-LC...

Output 1 (OUT 1, PIN 4)	Output 2 (OUT 2, PIN 2)
	Analog output 4 - 20 mA
	Analog output 0 - 20 mA
	Analog output 2 - 10 V
	Analog output 0 - 10 V
Alarm output NPN/ PNP/ PP	Alarm output NPN/ PNP/ PP
Frequency output PP	Frequency output PP
Communication mode KofiCom	
Communication mode IO-Link	
Control input	
SPDT contact (optional with ZUB-MANS-KON2)	SPDT contact (optional with ZUB-MANS-KON2)

Shock Resistance
DIN EN 60068-2-27:2010: 20 g (11 ms)

Vibration Resistance
DIN EN 60068-2-6:2008: 5 g (10...2000 Hz)

Weight (Connection G1/4): MAN-SC: ca. 360 g
MAN-LC: ca. 310 g
(Weights of other process connections deviate)



Digital Pressure Gauge Model MAN-SC/-LC

Order Details (Example: MAN-SC10G2A3000)

Model	Output	Mechanical Connection	Measuring Range ¹⁾²⁾	Electrical Connection	Sensor Gasket	Special Version
MAN-SC.. (Digital manometer, 9 V battery)	..10.. = without	..N2.. = 1/4" NPT male ..N4.. = 1/2" NPT male ..G2.. = G 1/4 male ..G4²⁾.. = G 1/2 male ..C2.. = Connection bottom 1/4" NPT, with cooling fins ..C4.. = Connection bottom 1/2" NPT, with cooling fins ..K2.. = Connection bottom G 1/4 male, with cooling fins ..K4.. = Connection bottom G 1/2 male, with cooling fins ..M1.. = Connection bottom M16x1.5 male ..M2.. = Connection bottom M20x1.5 male ..M6.. = Connection M6 female with O-ring groove ..U7.. = Connection bottom 7/16-20 UNF DIN 3866 ..D2.. = Connection bottom G 1/4 male DIN 3852-E + FKM gasket ..YY.. = On request ..DM³⁾.. = Assembly with diaphragm seal	..EC.. = -20...0 inHg ..ED.. = -30...0 inHg ..E0⁵⁾.. = -30...15 inHg/PSI ..E1⁵⁾.. = -30...30 inHg/PSI ..E2⁵⁾.. = -30...60 inHg/PSI ..E3⁵⁾.. = -30...100 inHg/PSI ..E4⁵⁾.. = -30...150 inHg/PSI ..F1.. = 0...10 PSI ..F2.. = 0...15 PSI ..F3.. = 0...30 PSI ..F4.. = 0...50 PSI ..F5.. = 0...60 PSI ..F6.. = 0...100 PSI ..F7.. = 0...150 PSI ..F8.. = 0...200 PSI ..F9.. = 0...300 PSI ..F0.. = 0...500 PSI ..G1.. = 0...1,000 PSI ..G2.. = 0...1,450 PSI ..G3.. = 0...2,000 PSI ..G4.. = 0...2,300 PSI ..G5.. = 0...3,000 PSI ..G6.. = 0...3,600 PSI ..G7.. = 0...5,000 PSI ..G8.. = 0...5,800 PSI ..G9.. = 0...7,500 PSI ..G0.. = 0...10,000 PSI ..H1²⁾.. = 0...15,000 PSI ..H2²⁾.. = 0...20,000 PSI ..AC.. = -0.6...0 bar ..AD.. = -1...0 bar ..A0.. = -1...0.6 bar ..A1.. = -1...1.5 bar ..A2.. = -1...3 bar ..A3.. = -1...5 bar ..A4.. = -1...9 bar ..A5.. = -1...15 bar ..B1.. = 0...0.6 bar ..B2.. = 0...1 bar ..B3.. = 0...1.6 bar ..B4.. = 0...2.5 bar ..B5.. = 0...4 bar ..B6.. = 0...6 bar ..B7.. = 0...10 bar ..B8.. = 0...16 bar ..B9.. = 0...25 bar ..B0.. = 0...40 bar ..C1.. = 0...60 bar ..C2.. = 0...100 bar ..C3.. = 0...160 bar ..C9⁴⁾.. = 0...200 bar ..C4.. = 0...250 bar ..C5.. = 0...400 bar ..C6.. = 0...600 bar ..C0⁴⁾.. = 0...700 bar ..D7²⁾.. = 0...1,000 bar ..D8²⁾.. = 0...1,600 bar	..0.. = without ..L⁷⁾.. = 9 V lithium battery ..A⁸⁾.. = Absolute Pressure 0...1 bar to 0...10 bar ..S.. = oil and fat free for oxygen ..Y.. = Special (Please specify in writing)		
					MAN-LC.. (Digital manometer w/ backlight, 18-32 V _{DC} supply)	..30.. = With 2 configurable outputs (OUT1, OUT2)

¹⁾ All measuring units available via programming: PSI, bar, mbar, kPa, MPa, kN, N, torr, inWC, mmWC, inHg, user specified

²⁾ Measuring ranges >10,000 PSI only with G 1/2 male mechanical connection

³⁾ Diaphragm seal model and application data to be specified in clear text. Application Index on the last two pages of this data sheet to be filled out, or discuss with your local KOBOLD technical sales office. For a summary of diaphragm seal models and possible ranges, see page 11 and following. For dimensional details, consult our DRM data sheet at www.koboldusa.com. In case of ordering a remote diaphragm seal with capillary and for mounting with wall mounting bracket MZB-709... acc. to DIN 16286, an additional ordering adaptor, model MZB-708/... acc. to DIN 16281 is necessary for factory sided integration in diaphragm seal assembly is mandatory.

⁴⁾ Measuring range for hydraulic applications

⁵⁾ Display in PSI

⁶⁾ Use this option for pressure above 10,000 PSI. For this range there is no gasket, it is fully welded

⁷⁾ Instead of 9 V alkaline- no shipping by air freight (MAN-SC only)

⁸⁾ For measuring ranges B2 to B7 or F2 to F7

Accessories for Standard Versions

Order Code	Description	Image
ZUB-MANS-KON1	Plug-in retrofit kit with 2x potential-free SPDT contacts, comprised of a relay board and 2x socket head cap screws M2x16 (only for MAN-LC...) Switching capacity per contact: 30V _{AC/DC} , max. 1 A	
ZUB-MANS-KON2	Plug-in retrofit kit with 2x potential-free SPDT contacts, comprised of a relay board and 2x socket head cap screws M2x16 and 8-pin M12 connector (only for MAN-LC...) Switching capacity per contact: 30V _{AC/DC} , max. 1 A	
ZUB-MANS-KAP01	Rubber impact protection sleeve MAN-SC/-LC, Black	
ZUB-MANS-KAP02	Rubber impact protection sleeve MAN-SC/-LC, Orange	

Accessories for M12x1 Round Connector

Round Connector, M12x1 Socket, Straight								
Technical Details	Image							
	Model	ZUB-KAB-12D500	807.007	807.007/5M	807.007/10M	807.008	807.008/5M	807.008/10M
Way of Connection	Screws	2 m cable, PVC jacket, PUR molded body	5 m cable, PVC jacket, PUR molded body	10 m cable, PVC jacket, PUR molded body	2 m cable, PVC jacket, PUR molded body	5 m cable, PVC jacket, PUR molded body	10 m cable, PVC jacket, PUR molded body	10 m cable, PVC jacket, PUR molded body
Male Insert	PBT / PA66	PUR			PUR			
Ring Nut	PA66	Zinc die casting / Brass, nickel-plated			Zinc die casting / Brass, nickel-plated			
Cable Outlet / Cable Diameter	4 - 6 mm	6 mm			6 mm			
Cross Section of Wire	max. 0.75 mm ²	0.34 mm ²			0.25 mm ²			
Number of Contacts	5	5			8			
Protection	IP 67	IP 67			IP 67			
Rated Voltage	60 V	60 V			60 V			
Rated Current	4 A	2 A			2 A			
Ambient Temperature	-40...185°F	-13...176°F		-13...185°F	-13...176°F		-13...185°F	

Round Connector, M12x1 Socket, Straight		Round Connector, M12x1 Socket, Angled						
Technical Details	Image							
	Model	ZUB-KAB-12D800	807.007/90D	807.007/90D5M	807.007/90D10M	807.008/90D	807.008/90D5M	807.008/90D10M
Way of Connection	Screws	2 m cable, PVC jacket, PUR molded body	5 m cable, PVC jacket, PUR molded body	10 m cable, PVC jacket, PUR molded body	2 m cable, PVC jacket, PUR molded body	5 m cable, PVC jacket, PUR molded body	10 m cable, PVC jacket, PUR molded body	10 m cable, PVC jacket, PUR molded body
Male Insert	PA	PUR			PUR			
Ring Nut	CuZn (brass)	Zinc die casting / Brass, nickel-plated			Zinc die casting / Brass, nickel-plated			
Cable Outlet / Cable Diameter	6 - 8 mm	6 mm			6 mm			
Cross Section of Wire	max. 0.5 mm ²	0.34 mm ²			0.25 mm ²			
Number of Contacts	8	5			8			
Protection	IP 67	IP 67			IP 67			
Rated Voltage	30 V	60 V			60 V			
Rated Current	2 A	2 A			2 A			
Ambient Temperature	-13...185°F	-13...185°F	-13...176°F		-13...185°F	-13...176°F		

**Electrical Connection MAN-LC
Plug Version, 5-pin**

Plug Version (Basic)	<p>MAN-LC30 (standard version, delivery scope)</p>
PIN 1	Supply +Vs
PIN 2	Output 2
PIN 3	Supply GND
PIN 4	Output 1 IO-Link
PIN 5	-

Possible Options for User Modification, 5-pin, with Optional Retrofit Kit ZUB-MANS-KON1*

5-pin	Modification	PIN 1	PIN 2	PIN 3	PIN 4	PIN 5	Order Code**
Option 5.1 (recommended)	2 N/O contacts, 1 common Relay COM	Supply +Vs	Relay 2 N/O contact	Supply GND	Relay 1 N/O contact	Relay 1+2 Relay COM	ABG-MANLC51
Option 5.2	2 N/C contacts, 1 common Relay COM	Supply +Vs	Relay 2 N/C contact	Supply GND	Relay 1 N/C contact	Relay 1+2 Relay COM	ABG-MANLC52
Option 5.3	1 N/C contact, 1 N/O contact, 1 Relay COM	Supply +Vs	Relay 2 N/C contact	Supply GND	Relay 1 N/O contact	Relay 1+2 Relay COM	ABG-MANLC53
Option 5.4	1 Output IO-Link, 1 N/O contact, 1 Relay COM	Supply +Vs	Relay 2 N/O contact	Supply GND	Output 1 IO-Link	Relay 2 Relay COM	ABG-MANLC54
Option 5.5	1 Output IO-Link, 1 N/C contact, 1 Relay COM	Supply +Vs	Relay 2 N/C contact	Supply GND	Output 1 IO-Link	Relay 1 Relay COM	ABG-MANLC55
Option 5.6	1 Output 4...20 mA, 1 N/O contact, 1 Relay COM	Supply +Vs	Output 2 (4...20 mA)	Supply GND	Relay 1 N/O contact	Relay 1 Relay COM	ABG-MANLC56
Option 5.7	1 Output 4...20 mA, 1 N/C contact, 1 Relay COM	Supply +Vs	Output 2 (4...20 mA)	Supply GND	Relay 1 N/C contact	Relay 1 Relay COM	ABG-MANLC57

* Modification instructions included in instruction manual
** Factory configuration, possible while ordering a new unit

Possible Options for User Modification, 8-pin, with Optional Retrofit Kit ZUB-MANS-KON2*

8-pin	Modification	PIN 1	PIN 2	PIN 3	PIN 4	PIN 5	PIN 6	PIN 7	PIN 8	Order Code**
Option 8.1 (recommended)	1 Output 4...20 mA, 1 N/C contact, 1 N/O contact, 1 Relay COM	Supply +Vs	Output 2 (4...20 mA)	Supply GND	Relay 1 Relay 1 COM	Relay 1 N/O contact	Relay 1 N/C contact	-	-	ABG-MANLC81
Option 8.2	2 N/C contacts, 2 N/O contacts, 2 Relay COM*	Supply +Vs	Relay 2 Relay 2 COM	Supply GND	Relay 1 Relay 1 COM	Relay 1 N/O contact	Relay 1 N/C contact	Relay 2 N/O contact	Relay 2 N/C contact	ABG-MANLC82
Option 8.3	1 Output IO-Link, 1 N/C contact, 1 N/O contact, 1 Relay COM*	Supply +Vs	Relay 2 Relay 2 COM	Supply GND	Output 1 IO-Link	-	-	Relay 2 N/O contact	Relay 2 N/C contact	ABG-MANLC83

* Modification instructions included in instruction manual
** Factory configuration, possible while ordering a new unit

Display Layout
MAN-SC

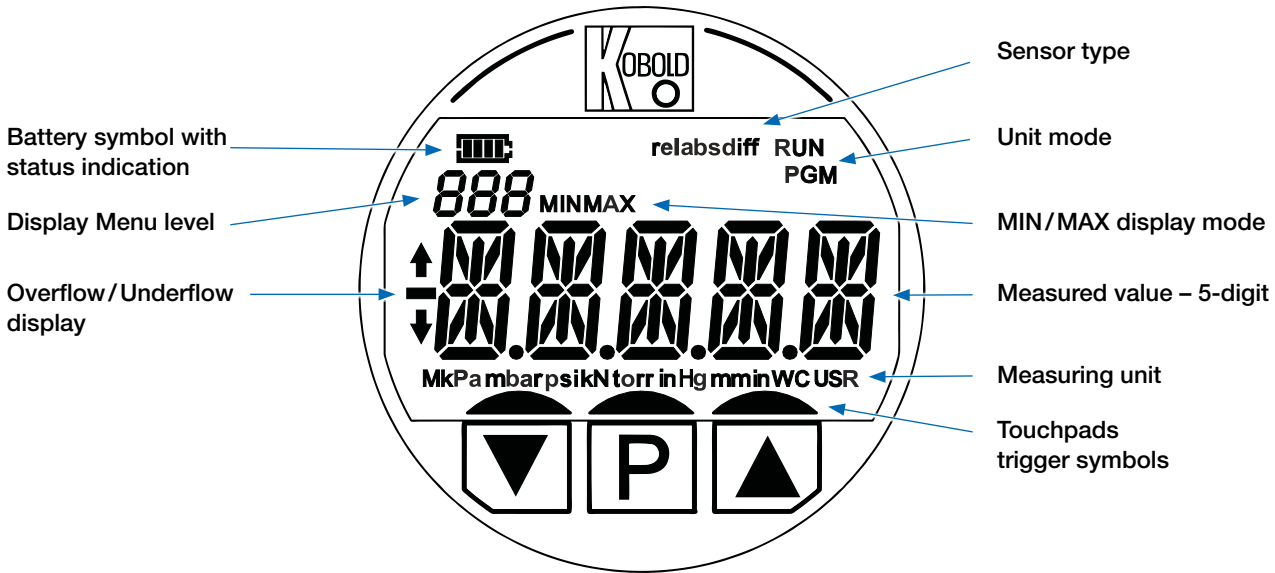

MAN-LC

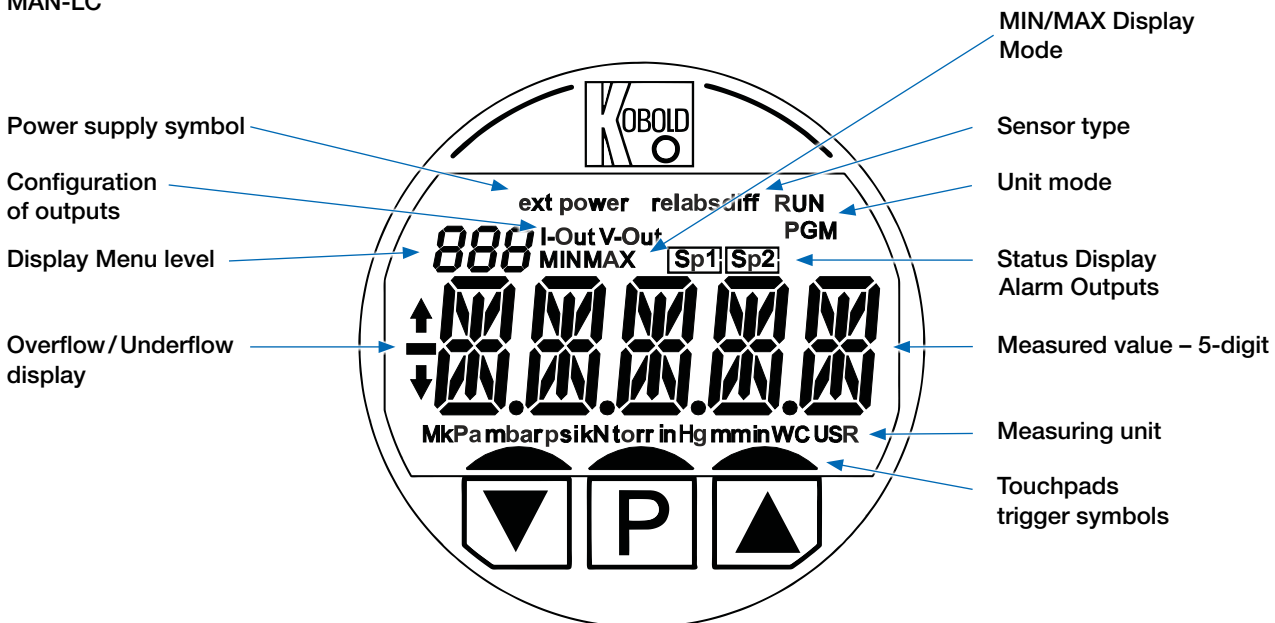

Dimensions

MAN-SC

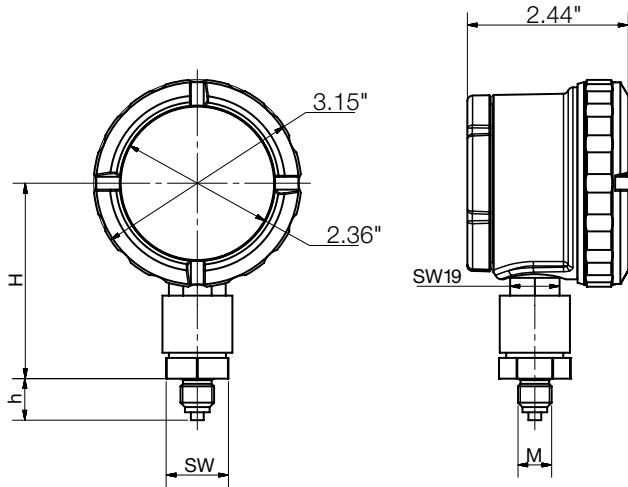

Rubber Protection Sleeve ZUB-MANS-KAP01 (Optional)

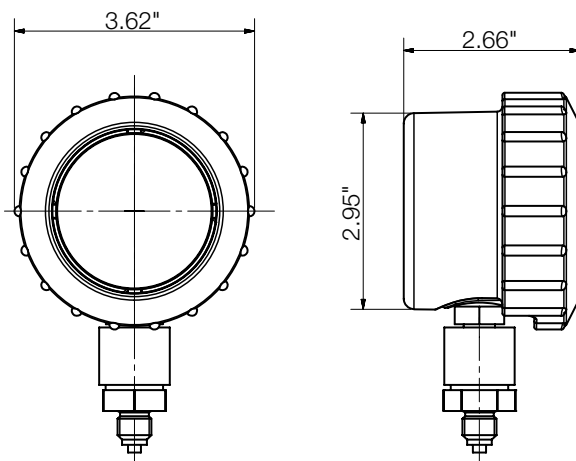

MAN-LC

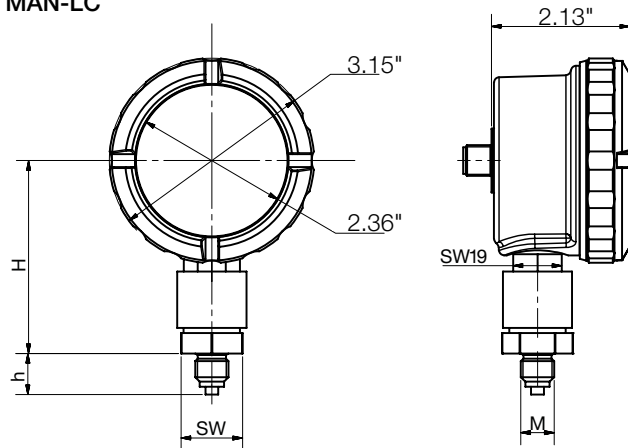

Mechanical Connection	Code	M	SW	H+2 mm*	h
G 1/4 male	G2	G 1/4 male	0.94"	2.95"	0.65"
G 1/2 male	G4	G 1/2 male	0.94"	2.95"	1.00"
1/4" NPT male	N2	1/4" NPT	0.94"	2.95"	0.57"
1/2" NPT male	N4	1/2" NPT	0.94"	2.95"	0.75"
G 1/4 male *** 1000 + 1600 bar / 15+20 k PSI	G2	G 1/4 male	1.06"	3.27"	0.65"
G 1/2 male *** 1000 + 1600 bar / 15+20 k PSI	G4	G 1/2 male	1.06"	3.27"	1.00"
1/4" NPT male *** 1000 + 1600 bar / 15+20 k PSI	N2	1/4" NPT	1.06"	3.27"	0.57"
1/2" NPT male *** 1000 + 1600 bar / 15+20 k PSI	N4	1/2" NPT	1.06"	3.31"	0.75"
Connection bottom G 1/4 male with cooling fins ***	K2	G 1/4 male	0.94"	3.72"	0.65"
Connection bottom G 1/2 male with cooling fins ***	K4	G 1/2 male	0.94"	3.72"	1.00"
Connection bottom 1/4" NPT with cooling fins ***	C2	1/4" NPT	0.94"	3.72"	0.57"
Connection bottom 1/2" NPT with cooling fins ***	C4	1/2" NPT	0.94"	3.72"	0.75"
Connection bottom M20x1.5 male	M2	M20x1.5	0.94"	3.07"	0.93"
Connection bottom M16x1.5 male	M1	M16x1.5	0.94"	3.07"	0.93"
Connection M6 female with O-ring groove	M6	M6 female	0.94"	2.95"	-
7/16 UNF DIN 3866 stainless steel	U7	7/16 UNF	0.94"	2.95"	0.59"
G 1/4 male DIN 3852-E stainless steel + FKM gasket	D2	G 1/4 male	0.94"	2.95"	0.47"

* The counter nut at the sensor can be loosened by the customer and the electronic housing rotated max. 360°. This changes the height H by approx. +1.75 mm (0.07") (corresponds to thread slope). This rotation enables any orientation of the unit after final mounting is done.

Example of MAN-SC/-LC Direct Assembled with Diaphragm Seal
(for dimensional details, see DRM data sheet)

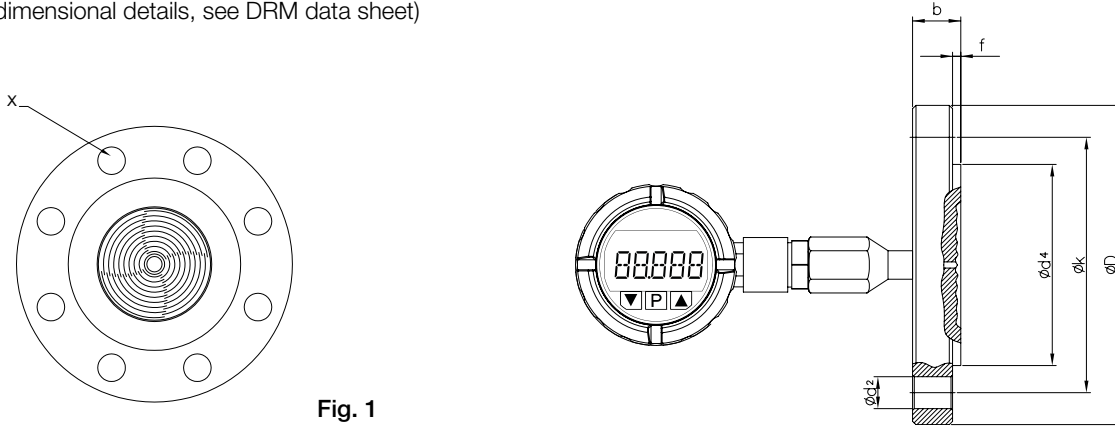

Fig. 1

Example of MAN-SC/-LC Remote Assembled with Diaphragm Seal and Capillary
(for dimensional details, see DRM data sheet)

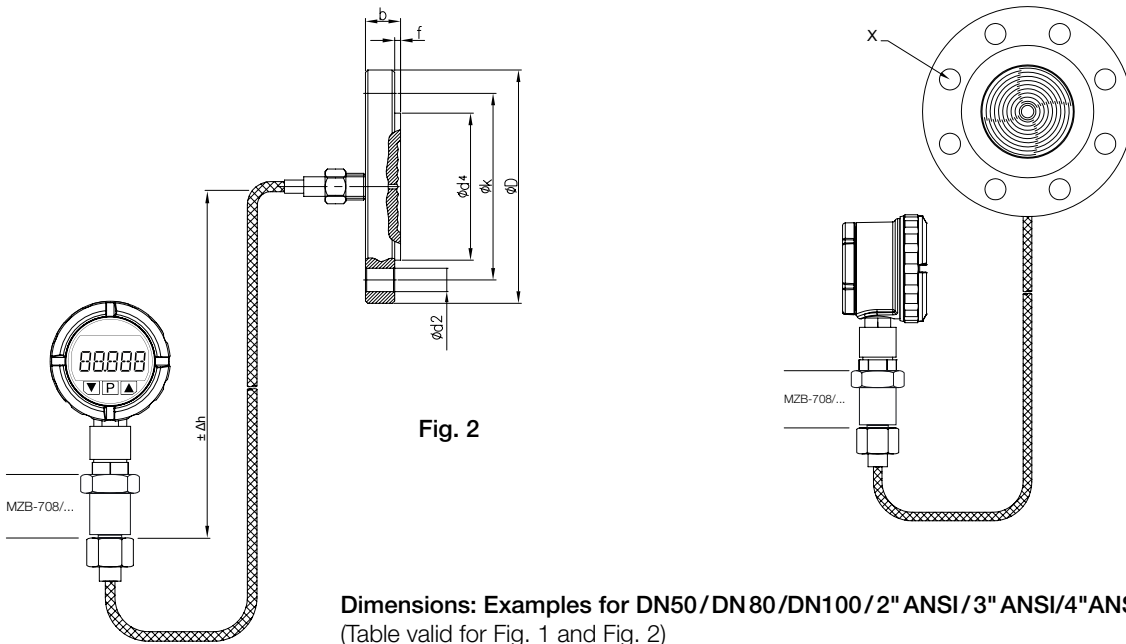
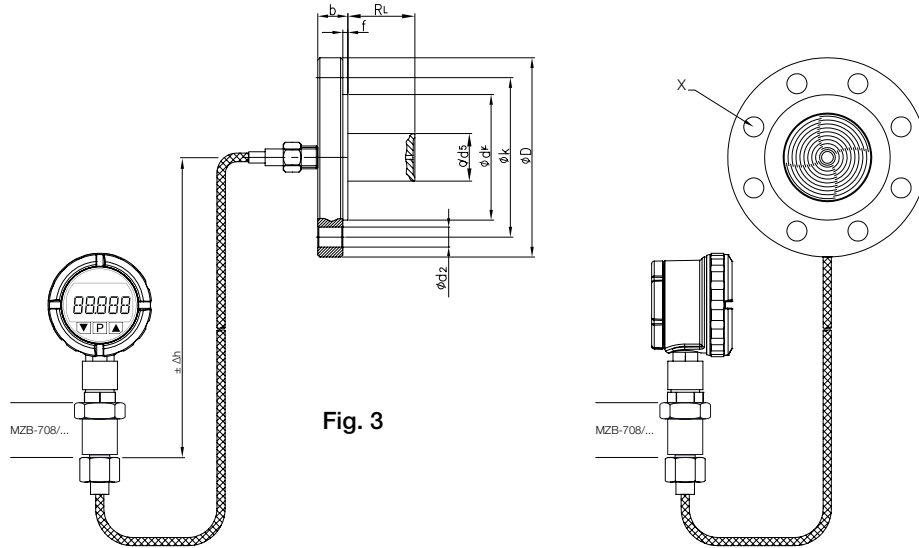

Fig. 2

Dimensions: Examples for DN50/DN 80/DN100/2" ANSI/3" ANSI/4" ANSI
(Table valid for Fig. 1 and Fig. 2)

Flange Type	D	k	d ²	b	f	d ⁴	X
DN50 PN16	6.50"	4.92"	0.71"	0.71"	0.08"	4.02"	0.16"
DN50 PN40	6.50"	4.92"	0.71"	0.79"	0.08"		0.16"
2" ANSI Cl. 150	6.00"	4.75"	0.75"	0.75"	0.08"	3.62"	0.16"
2" ANSI Cl. 300	6.50"	5.00"	0.75"	0.88"	0.08"		0.31"
DN80 PN16	7.87"	6.30"	0.71"	0.79"	0.08"	5.43"	0.31"
DN80 PN40	7.87"	6.30"	0.71"	0.94"	0.08"		0.31"
3" ANSI Cl. 150	7.50"	6.00"	0.75"	0.94"	0.06"	5.00"	0.16"
3" ANSI Cl. 300	8.25"	6.63"	0.87"	1.12"	0.06"		0.31"
DN100 PN16	8.66"	7.09"	0.71"	0.79"	0.08"	5.87"	0.31"
DN100 PN40	9.25"	7.48"	0.87"	0.94"	0.08"		0.31"
4" ANSI Cl. 150	9.00"	7.50"	0.75"	0.94"	0.06"	6.19"	0.31"
4" ANSI Cl. 300	10.00"	7.87"	0.87"	1.26"	0.06"		0.31"

Example of MAN-SC/-LC Remote Assembled with Extended Diaphragm Seal and Capillary
 (for dimensional details, see DRM data sheet)



Dimensions: Examples for DN50/DN80/DN100/2" ANSI/3" ANSI/4" ANSI

Flange type	D	k	d ²	b	f	d ⁴	X	d ⁵	R _L
DN50 PN16	6.50"	4.92"	0.71"	0.71"	0.08"	4.02"	0.16"	1.89"	50 mm (2")/ 100 mm (4")/ 150 mm (6")/ 200 mm (8")/ (customer specified)
DN50 PN40	6.50"	4.92"	0.71"	0.79"	0.08"		0.16"	1.89"	
2" ANSI Cl. 150	6.00"	4.75"	0.75"	0.75"	0.08"	3.62"	0.16"	1.89"	
2" ANSI Cl. 300	6.50"	5.00"	0.75"	0.88"	0.08"		0.31"	1.89"	
DN80 PN16	7.87"	6.30"	0.71"	0.79"	0.08"	5.43"	0.31"	3.00"	
DN80 PN40	7.87"	6.30"	0.71"	0.94"	0.08"		0.31"	3.00"	
3" ANSI Cl. 150	7.50"	6.00"	0.75"	0.94"	0.06"	5.00"	0.16"	3.00"	
3" ANSI Cl. 300	8.25"	6.63"	0.87"	1.12"	0.06"		0.31"	3.00"	
DN100 PN16	8.66"	7.09"	0.71"	0.79"	0.08"	5.87"	0.31"	3.50"	
DN100 PN40	9.25"	7.48"	0.87"	0.94"	0.08"	5.87"	0.31"	3.50"	
4" ANSI Cl. 150	9.00"	7.50"	0.75"	0.94"	0.06"	6.19"	0.31"	3.50"	
4" ANSI Cl. 300	10.00"	7.87"	0.87"	1.26"	0.06"	6.19"	0.31"	3.50"	

Diaphragm Seal Models (Direct or Remote Assembly)

(Standard device without additional options (e.g. coatings, special materials etc.).

For dimensions/technical data, see DRM data sheet. Accuracy: Class 0.5 + influence of seal).

Over and under ranges of the min./max. span might be possible, but must be verified by KOBOLD for each application.



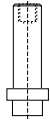
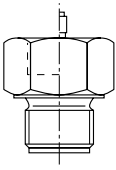
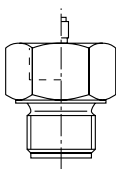
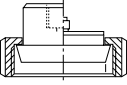



The indicated min./max. spans do not consider any coating of diaphragm seals. For additional information contact KOBOLD.

Model DRM	Size Code	Size	Note	Ø Diaphragm (mm)	Max. Media Temperature	Min. Span (PSI)	Max. Span (PSI)]
DRM-189 	F23	Ø 18	for homogenizing machines, direct	Ø 18	248 °F	0...58	14,500
DRM-600 	R15	G ½	fixed male thread, direct	Ø 18	212 °F	0...58*	14,500
	R20	G ¾		Ø 23.8		0...23*	14,500
	R25	G 1		Ø 29.5		0...14.5	8,700
	R32	G 1 ¼		Ø 38		0...0.6	8,700
	R40	G 1 ½		Ø 40		0...8.7	8,700
	N15	½" NPT		Ø 18		0...58*	14,500
	N20	¾" NPT		Ø 18		0...58*	14,500
	N25	1" NPT		Ø 23.8		0...23	8,700
	N32	1 ¼" NPT		Ø 34.5		0...14.5	8,700
	M20	M20 x 1.5		Ø 18		0...58	8,700
	M48	M 48 x 3		Ø 40		0...8.7	8,700
DRM-601 	R15	G ½	fixed male thread with capillary	Ø 18	392 °F	0...58*	14,500
	R20	G ¾		Ø 23.8		0...23*	14,500
	R25	G 1		Ø 29.5		0...14.5	8,700
	R32	G 1 ¼		Ø 38		0...8.7	8,700
	R40	G 1 ½		Ø 40		0...8.7	8,700
	N15	½" NPT		Ø 18		0...58*	14,500
	N20	¾" NPT		Ø 18		0...58*	14,500
	N25	1" NPT		Ø 23.8		0...23	8,700
	N32	1 ¼" NPT		Ø 34.5		0...14.5	8,700
	M20	M20 x 1.5		Ø 18		0...58	8,700
	M48	M 48 x 3		Ø 40		0...8.7	8,700
DRM-602 DIN 11851 	R20	DN 20	dairy connection, direct	Ø 18	212 °F	0...58	580
	R25	DN 25		Ø 23.8		0...23	580
	R32	DN 32		Ø 29.5		0...14.5	580
	R40	DN 40		Ø 38		0...8.7	580
	R50	DN 50		Ø 45.5		0...5.8	362.5
	R65	DN 65		Ø 64		0...3.6	362.5
	R80	DN 80		Ø 64		0...3.6	362.5
	R1H	DN 100		Ø 64		0...3.6	362.5

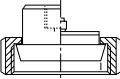
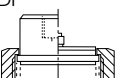
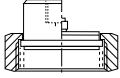
* On request only after technical clarification





Diaphragm Seal Models (Direct or Remote Assembly) (continued)

Model DRM	Size Code	Size	Note	Ø Diaphragm (mm)	Max. Media Temperature	Min. Span (PSI)	Max. Span (PSI)
DRM-603 DIN 11851 	R20	DN 20	dairy connection, capillary	Ø 18	392 °F	0...58	580
	R25	DN 25		Ø 23.8		0...23	580
	R32	DN 32		Ø 29.5		0...14.5	580
	R40	DN 40		Ø 38		0...8.7	580
	R50	DN 50		Ø 45.5		0...5.8	362.5
	R65	DN 65		Ø 64		0...3.6	362.5
	R80	DN 80		Ø 64		0...3.6	362.5
	R1H	DN 100		Ø 64		0...3.6	362.5
DRM-604 IDF 	R25	1"	IDF socket with union nut, direct	Ø 29.5	212 °F	0...23	580
	R40	1 1/2"		Ø 42		0...14.5	580
	R50	2"		Ø 56		0...8.7	580
DRM-605 IDF 	R25	1"	IDF socket with union nut, capillary	Ø 29.5	392 °F	0...14.5	580
	R40	1 1/2"		Ø 42		0...8.7	580
	R50	2"		Ø 56		0...5.8	580
DRM-606 	R20	G 3/4	capsule seal with rotatable male, capillary	short capsule	662 °F	0...8.7	8,700
	R28	M28 x 1.5				0...8.7	8,700
DRM-607 	R15	G 1/2	capsule seal with fixed male, direct	long capsule	212 °F	0...14.5	8,700
	R20	G 3/4				0...14.5	8,700
DRM-607/1 	R15	G 3/4	Capsule seal with fixed male, direct	long capsule	212 °F	0...14.5	8,700
	R20	G 1				0...14.5	8,700
DRM-608/1 	R20	G 3/4	capsule seal with union nut, capillary	long capsule	662 °F	0...14.5	8,700
	R25	G 1	capsule seal with union nut, capillary	long capsule		0...14.5	8,700
DRM-610 SMS 	R40	1 1/2"	SMS socket with union nut, direct	Ø 34.5	212 °F	0...14.5	580
	R50	2"		Ø 45.5		0...5.8	580



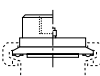
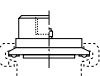
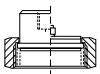
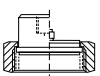



Diaphragm Seal Models (Direct or Remote Assembly) (continued)

Model DRM	Size Code	Size	Note	Ø Diaphragm (mm)	Max. Media Temperature	Min. Span (PSI)	Max. Span (PSI)
DRM-611 SMS 	R40	1 1/2"	SMS socket with union nut, capillary	Ø 34.5	392 °F	0...14.5	580
	R50	2"		Ø 45.5		0...5.8	580
DRM-612 Clamp 	R25	1"	Tri-Clamp®, direct	Ø 18	212 °F	0...58	232
	F40	1 1/2"		Ø 35.5		0...14.5	232
	F50	2"		Ø 45.5		0...5.8	232
	R65	2 1/2"		Ø 52		0...5.8	232
	R80	3"		Ø 64		0...3.6	145
DRM-613 Clamp 	R25	1"	Tri-Clamp®, capillary	Ø 18	392 °F	0...58	232
	F40	1 1/2"		Ø 35.5		0...14.5	232
	F50	2"		Ø 45.5		0...5.8	232
	R65	2 1/2"		Ø 52		0...5.8	232
	R80	3"		Ø 64		0...3.6	145
DRM-614 APV-RJT 	R20	1"	union-nut, direct	Ø 29.5	212 °F	0...23	1,450
	R40	1 1/2"		Ø 42.5		0...8.7	1,450
	R50	2"		Ø 56		0...5.8	1,450
DRM-615 APV-RJT 	R20	1"	union-nut, capillary	Ø 29.5	392 °F	0...23	1,450
	R40	1 1/2"		Ø 42.5		0...8.7	1,450
	R50	2"		Ø 56		0...5.8	1,450
DRM-616 	R45	M45 x 2	union-nut, direct	Ø 23.8	212 °F	0...23	23,200
DRM-617 	R45	M45 x 2	union-nut, capillary	Ø 23.8	248 °F	0...23	23,200



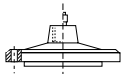
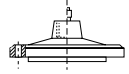
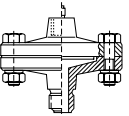
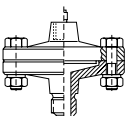

Diaphragm Seal Models (Direct or Remote Assembly) (continued)

Model DRM	Size Code	Size	Note	Ø Diaphragm (mm)	Max. Media Temperature	Min. Span (PSI)	Max. Span (PSI)
 DRM-620	R20	G $\frac{3}{4}$	union-nut, capillary	Ø 23.8	662°F	0...23	8,700
 DRM-620/1	R20	G $\frac{3}{4}$	union-nut, capillary	Ø 23.8	662°F	0...23	8,700
 DRM-621	F38	Ø 38 mm	flange, direct	Ø 38	482°F	0...5.8	580
 DRM-622	F48	Ø 48 mm	flange, direct	Ø 48	212°F	0...5.8	580
	F48 1	Ø 48 mm		Ø 48		0...5.8	580
	F48 2	Ø 48 mm		Ø 48		0...5.8	580
 DRM-622/1	F48	Ø 48 mm	flange, capillary	Ø 48	392°F	0...5.8	580
	F48 1	Ø 48 mm		Ø 48		0...5.8	580
	F48 2	Ø 48 mm		Ø 48		0...5.8	580
 DRM-624	F1H	Ø 100 mm	flange, direct	Ø 63.5	212°F	0...3.6	580
	F1H T	Ø 100 mm	flange, direct			0...3.6	580
 DRM-624/1	F1H	Ø 100 mm	flange, capillary		482°F	0...3.6	580
 DRM-625	R15	G $\frac{1}{2}$	fixed male, direct	Ø 63.5	212°F	0...3.6	580
	N15	$\frac{1}{2}$ " NPT				0...3.6	580
	I15	G $\frac{1}{2}$ female				0...3.6	580
 DRM-625/1	R15	G $\frac{1}{2}$	fixed male, capillary	Ø 63.5	482°F	0...3.6	580
	N15	$\frac{1}{2}$ " NPT				0...3.6	580
	I15	G $\frac{1}{2}$ female				0...3.6	580

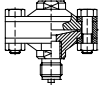
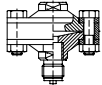
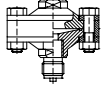
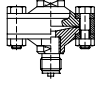
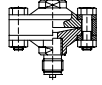
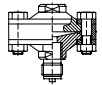
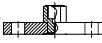

Diaphragm Seal Models (Direct or Remote Assembly) (continued)

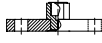
Model DRM	Size Code	Size	Note	Ø Diaphragm (mm)	Max. Media Temperature	Min. Span (PSI)	Max. Span (PSI)
DRM-626 PN 25 	R08 A025	G ¼ male	fixed male, direct	Ø 56	176 °F	0...5.8	362.5
	R08 I025	G ¼ female	fixed female, direct	Ø 56		0...5.8	362.5
	R15 A025	G ½ male	fixed male, direct	Ø 56		0...5.8	362.5
	R15 I025	G ½ female	fixed female, direct	Ø 56		0...5.8	362.5
	N15 A025	½" NPT male	fixed male, direct	Ø 56		0...5.8	362.5
DRM-626 PN 100 	R08 A100	G ¼ male	fixed male, direct	Ø 56	176 °F	0...5.8	1,450
	R08 I100	G ¼ female	fixed female, direct	Ø 56		0...5.8	1,450
	R15 A100	G ½ male	fixed male, direct	Ø 56		0...5.8	1,450
	R15 I100	G ½ female	fixed female, direct	Ø 56		0...5.8	1,450
	N15 A100	½" NPT male	fixed male, direct	Ø 56		0...5.8	1,450
DRM-626 PN 250 	R08 A250	G ¼ male	fixed male, direct	Ø 56	176 °F	0...5.8	3,625
	R08 I250	G ¼ female	fixed female, direct	Ø 56		0...5.8	3,625
	R15 A250	G ½ male	fixed male, direct	Ø 56		0...5.8	3,625
	R15 I250	G ½ female	fixed female, direct	Ø 56		0...5.8	3,625
	N15 A250	½" NPT male	fixed male, direct	Ø 56		0...5.8	3,625
DRM-627 PN 25 	R08 A025	G ¼ male	fixed male, capillary	Ø 56	482 °F	0...5.8	362.5
	R08 I025	G ¼ female	fixed female, capillary	Ø 56		0...5.8	362.5
	R15 A025	G ½ male	fixed male, capillary	Ø 56		0...5.8	362.5
	R15 I025	G ½ female	fixed female, capillary	Ø 56		0...5.8	362.5
	N15 A025	½" NPT male	fixed male, capillary	Ø 56		0...5.8	362.5
DRM-627 PN 100 	R08 A100	G ¼ male	fixed male, capillary	Ø 56	482 °F	0...5.8	1,450
	R08 I100	G ¼ female	fixed female, capillary	Ø 56		0...5.8	1,450
	R15 A100	G ½ male	fixed male, capillary	Ø 56		0...5.8	1,450
	R15 I100	G ½ female	fixed female, capillary	Ø 56		0...5.8	1,450
	N15 A100	½" NPT male	fixed male, capillary	Ø 56		0...5.8	1,450
DRM-627 PN 250 	R08 A250	G ¼ male	fixed male, capillary	Ø 56	482 °F	0...5.8	3,625
	R08 I250	G ¼ female	fixed female, capillary	Ø 56		0...5.8	3,625
	R15 A250	G ½ male	fixed male, capillary	Ø 56		0...5.8	3,625
	R15 I250	G ½ female	fixed female, capillary	Ø 56		0...5.8	3,625
	N15 A250	½" NPT male	fixed male, capillary	Ø 56		0...5.8	3,625
DRM-628 PN 06 	F25P06	DN 25	flange to EN1092-1, direct	Ø 24	176 °F	0...23	87
	F32P06	DN 32		Ø 30		0...23	87
	F40P06	DN 40		Ø 38		0...8.7	87
	F50P06	DN 50		Ø 48		0...5.8	87
	F65P06	DN 65		Ø 64		0...3.6	87
	F80P06	DN 80		Ø 64		0...3.6	87
	N1HP06	DN 100		Ø 64		0...3.6	87
DRM-628 PN 16 	F25P16	DN 25	flange to EN1092-1, direct	Ø 24	176 °F	0...23	232
	F32P16	DN 32		Ø 30		0...23	232
	F40P16	DN 40		Ø 38		0...8.7	232
	F50P16	DN 50		Ø 48		0...5.8	232
	F65P16	DN 65		Ø 64		0...3.6	232
	F80P16	DN 80		Ø 64		0...3.6	232
	N1HP16	DN 100		Ø 64		0...3.6	232
DRM-628 PN 40 	F25P40	DN 25	flange to EN1092-1, direct	Ø 24	176 °F	0...23	580
	F32P40	DN 32		Ø 30		0...23	580
	F40P40	DN 40		Ø 38		0...8.7	580
	F50P40	DN 50		Ø 48		0...5.8	580
	F65P40	DN 65		Ø 64		0...3.6	580
	F80P40	DN 80		Ø 64		0...3.6	580
	N1HP40	DN 100		Ø 64		0...3.6	580





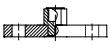
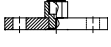
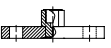
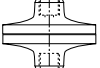
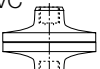
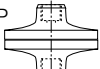
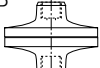
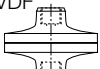
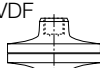

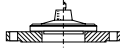

Diaphragm Seal Models (Direct or Remote Assembly) (continued)

Model DRM	Size Code	Size	Note	Ø Diaphragm (mm)	Max. Media Temperature	Min. Span (PSI)	Max. Span (PSI)
DRM-629 PN 06 	F25P06	DN 25	flange to EN1092-1, capillary	Ø 24	482 °F	0...23	87
	F32P06	DN 32		Ø 30		0...23	87
	F40P06	DN 40		Ø 38		0...8.7	87
	F50P06	DN 50		Ø 48		0...5.8	87
	F65P06	DN 65		Ø 64		0...3.6	87
	F80P06	DN 80		Ø 64		0...3.6	87
	F1HP06	DN 100		Ø 64		0...3.6	87
DRM-629 PN 16 	F25P16	DN 25	flange to EN1092-1, capillary	Ø 24	482 °F	0...23	232
	F32P16	DN 32		Ø 30		0...23	232
	F40P16	DN 40		Ø 38		0...8.7	232
	F50P16	DN 50		Ø 48		0...5.8	232
	F65P16	DN 65		Ø 64		0...3.6	232
	F80P16	DN 80		Ø 64		0...3.6	232
	F1HP16	DN 100		Ø 64		0...3.6	232
DRM-629 PN 40 	F25P40	DN 25	flange to EN1092-1, capillary	Ø 24	482 °F	0...23	580
	F32P40	DN 32		Ø 30		0...23	580
	F40P40	DN 40		Ø 38		0...8.7	580
	F50P40	DN 50		Ø 48		0...5.8	580
	F65P40	DN 65		Ø 64		0...3.6	580
	F80P40	DN 80		Ø 64		0...3.6	580
	F1HP40	DN 100		Ø 64		0...3.6	580
DRM 630 PVC 	R08	G ¼ female	fixed female, direct	Ø 64	104 °F	0...3.6	145
	R15	G ½ female		Ø 64		0...3.6	145
	N15	½" NPT female		Ø 64		0...3.6	145
DRM-630/1 PVC 	R08	G ¼ female	fixed female, capillary	Ø 64	104 °F	0...3.6	145
	R15	G ½ female		Ø 64		0...3.6	145
	N15	½" NPT female		Ø 64		0...3.6	145
DRM-631 PP 	R08	G ¼ female	fixed female, direct	Ø 64	104 °F	0...3.6	145
	R15	G ½ female		Ø 64		0...3.6	145
	N15	½" NPT female		Ø 64		0...3.6	145
DRM-631/1 PP 	R08	G ¼ female	fixed female, capillary	Ø 64	104 °F	0...3.6	145
	R15	G ½ female		Ø 64		0...3.6	145
	N15	½" NPT female		Ø 64		0...3.6	145
DRM-632 PVDF 	R08	G ¼ female	fixed female, direct	Ø 64	122 °F	0...3.6	232
	R15	G ½ female		Ø 64		0...3.6	232
	N15	½" NPT female		Ø 64		0...3.6	232
DRM-632/1 PVDF 	R08	G ¼ female	fixed female, capillary	Ø 64	122 °F	0...3.6	232
	R15	G ½ female		Ø 64		0...3.6	232
	N15	½" NPT female		Ø 64		0...3.6	232





Diaphragm Seal Models (Direct or Remote Assembly) (continued)

Model DRM	Size Code	Size	Note	Ø Diaphragm (mm)	Max. Media Temperature	Min. Span (PSI)	Max. Span (PSI)
 DRM-633	F50	DN50	flange to DIN2527 Form C, direct	Ø 64	212 °F	0...3.6	580
	F1H	DN 100		Ø 64		0...3.6	580
 DRM-633/1	F50	DN50	flange to DIN2527 Form C, capillary	Ø 64	482 °F	0...3.6	580
	F1H	DN 100		Ø 64		0...3.6	580
 DRM-634 150 lbs	A25P150	1"	flange to ASME B16.5, direct	Ø 30	176 °F	0...23	145
	A32P150	1¼"		Ø 38		0...8.7	145
	A40P150	1½"		Ø 38		0...8.7	145
	A50P150	2"		Ø 48		0...5.8	145
	A65P150	2½"		Ø 48		0...5.8	145
	A80P150	3"		Ø 64		0...3.6	145
	A90P150	3½"		Ø 64		0...3.6	145
	A1HP150	4"		Ø 64		0...3.6	145
 DRM-634 300 lbs	A25P300	1"	flange to ASME B16.5, direct	Ø 30	176 °F	0...23	290
	A32P300	1¼"		Ø 38		0...8.7	290
	A40P300	1½"		Ø 38		0...8.7	290
	A50P300	2"		Ø 48		0...5.8	290
	A65P300	2½"		Ø 48		0...5.8	290
	A80P300	3"		Ø 64		0...3.6	290
	A90P300	3½"		Ø 64		0...3.6	290
	A1HP300	4"		Ø 64		0...3.6	290
 DRM-634 600 lbs	A25P600	1"	flange to ASME B16.5, direct	Ø 30	176 °F	0...23	580
	A32P600	1¼"		Ø 38		0...8.7	580
	A40P600	1½"		Ø 38		0...8.7	580
	A50P600	2"		Ø 48		0...5.8	580
	A65P600	2½"		Ø 48		0...5.8	580
	A80P600	3"		Ø 64		0...3.6	580
	A90P600	3½"		Ø 64		0...3.6	580
	A1HP600	4"		Ø 64		0...3.6	580
 DRM-634 1500 lbs	A25P1K5	1"	flange to ASME B16.5, direct	Ø 30	176 °F	0...23	1,450
	A32P1K5	1¼"		Ø 38		0...8.7	1,450
	A40P1K5	1½"		Ø 38		0...8.7	1,450
	A50P1K5	2"		Ø 48		0...5.8	1,450
	A65P1K5	2½"		Ø 48		0...5.8	1,450
	A80P1K5	3"		Ø 64		0...3.6	1,450
	A90P1K5	3½"		Ø 64		0...3.6	1,450
	A1HP1K5	4"		Ø 64		0...3.6	1,450
 DRM-635 150 lbs	A25P150	1"	flange to ASME B16.5, capillary	Ø 30	482 °F	0...23	145
	A32P150	1¼"		Ø 38		0...8.7	145
	A40P150	1½"		Ø 38		0...8.7	145
	A50P150	2"		Ø 48		0...5.8	145
	A65P150	2½"		Ø 48		0...5.8	145
	A80P150	3"		Ø 64		0...3.6	145
	A90P150	3½"		Ø 64		0...3.6	145
	A1HP150	4"		Ø 64		0...3.6	145

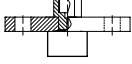
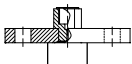
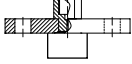

Diaphragm Seal Models (Direct or Remote Assembly) (continued)

Model DRM	Size Code	Size	Note	Ø Diaphragm (mm)	Max. Media Temperature	Min. Span (PSI)	Max. Span (PSI)
DRM-635 300 lbs 	A25P300	1"	flange to ASME B16.5, capillary	Ø 30	482 °F	0...23	290
	A32P300	1¼"		Ø 38		0...8.7	290
	A40P300	1½"		Ø 38		0...8.7	290
	A50P300	2"		Ø 48		0...5.8	290
	A65P300	2½"		Ø 48		0...5.8	290
	A80P300	3"		Ø 64		0...3.6	290
	A90P300	3½"		Ø 64		0...3.6	290
	A1HP300	4"		Ø 64		0...3.6	290
DRM-635 600 lbs 	A25P600	1"	flange to ASME B16.5, capillary	Ø 30	482 °F	0...23	580
	A32P600	1¼"		Ø 38		0...8.7	580
	A40P600	1½"		Ø 38		0...8.7	580
	A50P600	2"		Ø 48		0...5.8	580
	A65P600	2½"		Ø 48		0...5.8	580
	A80P600	3"		Ø 64		0...3.6	580
	A90P600	3½"		Ø 64		0...3.6	580
	A1HP600	4"		Ø 64		0...3.6	580
DRM-635 1500 lbs 	A25P1K5	1"	flange to ASME B16.5, capillary	Ø 30	482 °F	0...23	1,450
	A32P1K5	1¼"		Ø 38		0...8.7	1,450
	A40P1K5	1½"		Ø 38		0...8.7	1,450
	A50P1K5	2"		Ø 48		0...5.8	1,450
	A65P1K5	2½"		Ø 48		0...5.8	1,450
	A80P1K5	3"		Ø 64		0...3.6	1,450
	A90P1K5	3½"		Ø 64		0...3.6	1,450
	A1HP1K5	4"		Ø 64		0...3.6	1,450
DRM-637 PN06 	F25P06	DN25	flange to EN1092-1, direct	Ø 24	176 °F	0...23	87
	F32P06	DN32		Ø 30		0...23	87
	F40P06	DN40		Ø 38		0...14.5	87
	F50P06	DN50		Ø 48		0...8.7	87
	F65P06	DN65		Ø 64		0...3.6	87
	F80P06	DN80		Ø 64		0...3.6	87
	N1HP06	DN100		Ø 64		0...3.6	87
DRM-637 PN16 	F25P16	DN25	flange to EN1092-1, direct	Ø 24	176 °F	0...23	232
	F32P16	DN32		Ø 30		0...23	232
	F40P16	DN40		Ø 38		0...14.5	232
	F50P16	DN50		Ø 48		0...8.7	232
	F65P16	DN65		Ø 64		0...3.6	232
	F80P16	DN80		Ø 64		0...3.6	232
	N1HP16	DN100		Ø 64		0...3.6	232
DRM-637 PN40 	F25P40	DN25	flange to EN1092-1, direct	Ø 24	176 °F	0...23	580
	F32P40	DN32		Ø 30		0...23	580
	F40P40	DN40		Ø 38		0...14.5	580
	F50P40	DN50		Ø 48		0...8.7	580
	F65P40	DN65		Ø 64		0...3.6	580
	F80P40	DN80		Ø 64		0...3.6	580
	N1HP40	DN100		Ø 64		0...3.6	580

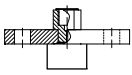
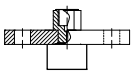
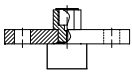
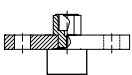
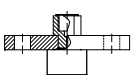
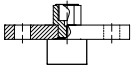

Diaphragm Seal Models (Direct or Remote Assembly) (continued)

Model DRM	Code	Size	Note	Ø Diaphragm (mm)	Max. Media Temperature	Min. Span (PSI)	Max. Span (PSI)
DRM-638 PN06 	F25P06	DN25	flange to EN1092-1, capillary	Ø 24	482 °F	0...23	87
	F32P06	DN32		Ø 30		0...23	87
	F40P06	DN40		Ø 38		0...14.5	87
	F50P06	DN50		Ø 48		0...8.7	87
	F65P06	DN65		Ø 64		0...3.6	87
	F80P06	DN80		Ø 64		0...3.6	87
	F1HP06	DN100		Ø 64		0...3.6	87
DRM-638 PN16 	F25P16	DN25	flange to EN1092-1, capillary	Ø 24	482 °F	0...23	232
	F32P16	DN32		Ø 30		0...23	232
	F40P16	DN40		Ø 38		0...14.5	232
	F50P16	DN50		Ø 48		0...8.7	232
	F65P16	DN65		Ø 64		0...3.6	232
	F80P16	DN80		Ø 64		0...3.6	232
	F1HP16	DN100		Ø 64		0...3.6	232
DRM-638 PN40 	F25P40	DN25	flange to EN1092-1, capillary	Ø 24	482 °F	0...23	580
	F32P40	DN32		Ø 30		0...23	580
	F40P40	DN40		Ø 38		0...14.5	580
	F50P40	DN50		Ø 48		0...8.7	580
	F65P40	DN65		Ø 64		0...3.6	580
	F80P40	DN80		Ø 64		0...3.6	580
	F1HP40	DN100		Ø 64		0...3.6	580
DRM-639 150 lbs 	A25P150	1"	flange to ASME B16.5, direct	Ø 30	176 °F	0...217	145
	A32P150	1¼"		Ø 38		0...217	145
	A40P150	1½"		Ø 38		0...217	145
	A50P150	2"		Ø 48		0...145	145
	A63P150	2½"		Ø 48		0...145	145
	A75P150	3"		Ø 64		0...58	145
	A85P150	3½"		Ø 64		0...58	145
	A1HP150	4"		Ø 64		0...58	145
DRM-639 300 lbs 	A25P300	1"	flange to ASME B16.5, direct	Ø 30	176 °F	0...217	290
	A32P300	1¼"		Ø 38		0...217	290
	A40P300	1½"		Ø 38		0...217	290
	A50P300	2"		Ø 48		0...145	290
	A63P300	2½"		Ø 48		0...145	290
	A75P300	3"		Ø 64		0...58	290
	A85P300	3½"		Ø 64		0...58	290
	A1HP300	4"		Ø 64		0...58	290
DRM-639 600 lbs 	A25P600	1"	flange to ASME B16.5, direct	Ø 30	176 °F	0...217	580
	A32P600	1¼"		Ø 38		0...217	580
	A40P600	1½"		Ø 38		0...217	580
	A50P600	2"		Ø 48		0...145	580
	A63P600	2½"		Ø 48		0...145	580
	A75P600	3"		Ø 64		0...58	580
	A85P600	3½"		Ø 64		0...58	580
	A1HP600	4"		Ø 64		0...58	580

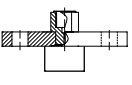
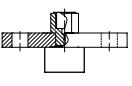
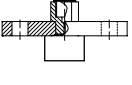
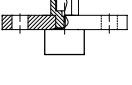
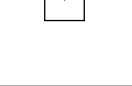

Diaphragm Seal Models (Direct or Remote Assembly) (continued)

Model DRM	Size Code	Size	Note	Ø Diaphragm (mm)	Max. Media Temperature	Min. Span (PSI)	Max. Span (PSI)
DRM-639 1500 lbs 	A25P1K5	1"	flange to ASME B16.5, direct	Ø 30	176 °F	0...217	1450
	A32P1K5	1¼"		Ø 38		0...217	1450
	A40P1K5	1½"		Ø 38		0...217	1450
	A50P1K5	2"		Ø 48		0...145	1450
	A63P1K5	2½"		Ø 48		0...145	1450
	A75P1K5	3"		Ø 64		0...58	1450
	A1HP1K5	4"		Ø 64		0...58	1450
	DRM-640 150 lbs 	A25P150		1"		flange to ASME B16.5, capillary	Ø 30
A32P150		1¼"	Ø 38	0...217	145		
A40P150		1½"	Ø 38	0...217	145		
A50P150		2"	Ø 48	0...145	145		
A63P150		2½"	Ø 48	0...145	145		
A75P150		3"	Ø 64	0...58	145		
A85P150		3½"	Ø 64	0...58	145		
A1HP150		4"	Ø 64	0...58	145		
DRM-640 300 lbs 	A25P300	1"	flange to ASME B16.5, capillary	Ø 30	482 °F	0...217	290
	A32P300	1¼"		Ø 38		0...217	290
	A40P300	1½"		Ø 38		0...217	290
	A50P300	2"		Ø 48		0...145	290
	A63P300	2½"		Ø 48		0...145	290
	A75P300	3"		Ø 64		0...58	290
	A85P300	3½"		Ø 64		0...58	290
	A1HP300	4"		Ø 64		0...58	290
DRM-640 600 lbs 	A25P600	1"	flange to ASME B16.5, capillary	Ø 30	482 °F	0...217	580
	A32P600	1¼"		Ø 38		0...217	580
	A40P600	1½"		Ø 38		0...217	580
	A50P600	2"		Ø 48		0...145	580
	A63P600	2½"		Ø 48		0...145	580
	A75P600	3"		Ø 64		0...58	580
	A85P600	3½"		Ø 64		0...58	580
	A1HP600	4"		Ø 64		0...58	580
DRM-640 1500 lbs 	A25P1K5	1"	flange to ASME B16.5, capillary	Ø 30	482 °F	0...217	1450
	A32P1K5	1¼"		Ø 38		0...217	1450
	A40P1K5	1½"		Ø 38		0...217	1450
	A50P1K5	2"		Ø 48		0...145	1450
	A63P1K5	2½"		Ø 48		0...145	1450
	A75P1K5	3"		Ø 64		0...58	1450
	A1HP1K5	4"		Ø 64		0...58	1450

Diaphragm Seal Models (Direct or Remote Assembly) (continued)

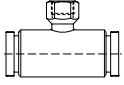
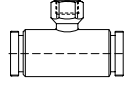
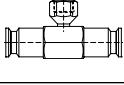
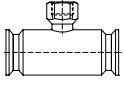
Model DRM	Size Code	Size	Note	Ø Diaphragm (mm)	Max. Media Temperature	Min. Span (PSI)	Max. Span (PSI)
DRM 500 ISO Sterile 	D15	DN 15	inline, direct	inline	176 °F	0...23	580
	D20	DN20		inline		0...23	580
	D25	DN25		inline		0...8.7	580
	D32	DN32		inline		0...8.7	580
	D40	DN40		inline		0...5.8	580
	D50	DN50		inline		0...5.8	580
DRM 501 ISO Sterile 	D15	DN 15	inline, capillary	inline	176 °F	0...23	580
	D20	DN20		inline		0...23	580
	D25	DN25		inline		0...8.7	580
	D32	DN32		inline		0...8.7	580
	D40	DN40		inline		0...5.8	580
	D50	DN50		inline		0...5.8	580
DRM 502 Clamp ISO 2852 	D15	DN 15	inline, direct	inline	176 °F	0...23	580
	D20	DN20		inline		0...23	580
	D25	DN25		inline		0...8.7	580
	D32	DN32		inline		0...8.7	580
	D40	DN40		inline		0...5.8	580
	D50	DN50		inline		0...5.8	580
DRM 503 Clamp ISO 2852 	D15	DN 15	inline, capillary	inline	176 °F	0...23	580
	D20	DN20		inline		0...23	580
	D25	DN25		inline		0...8.7	580
	D32	DN32		inline		0...8.7	580
	D40	DN40		inline		0...5.8	580
	D50	DN50		inline		0...5.8	580