

Large Size – Alloys

LS-800 Series – The General Purpose Workhorse for Water and Oils

- ▶ Stainless Steel or Brass Mountings
- ▶ 1 to 6 Actuation Levels
- ▶ Lengths to over 11 feet (3.4 m)
- ▶ CSA Listed

Rugged construction and multiple options provide the LS-800 Series with exceptional versatility. Longer and more substantial than other metallic models, the LS-800 is capable of supporting larger, more buoyant floats, and is physically stronger for better reliability in contaminated or turbulent media. This series offers SPST or SPDT switches, and a choice of mountings, floats and materials that can be configured for a wide range of applications in water, oils, chemicals and corrosive liquids.

Temperature Sensing

To save space and simplify wiring, GEMS can incorporate a temperature sensor in the end of the float stem on any model type LS-800. Two sensor types are available: Transducers for continuous output, and Thermostats for switch actuation. See Page B-25 for details.



Adjustable Mounting

Allows stem to travel up and down for fine tuning your actuation points. See next page.



LS-800 switches are U.L. Approved for Class I, Division 2, Groups B, C, D hazardous locations

They are also available with FM-approved, explosion-proof junction box for Class I, Division 1, Group D hazardous locations (Type 1 mounting excluded). Units must be specified with stainless steel floats and be assembled completely at GEMS.



ORDER IT!

Ordering is Easy! See Page B-26. Easy online ordering too!

UL Approved Explosion-Proof



1. Mounting Types

Each mounting type can be configured with stem lengths (L_0) and float material indicated in the table below. Mountings are also continued on following page.

Note: Sanitary flange mountings are also available, but not shown. Please contact factory. Type 1 and Type 8 mountings not FM approved.

	Type 1 1/2" NPT†	Type 8 1" NPT†	Type 2 1-1/4" NPT	Type 3 2" NPT	Type 4 3", 150# Dia. Flange
inch (mm)	1-1/4 (31.75) 5/16 (7.94) 0.745 FLATS	1-1/4 (31.75) 0.745 FLATS 1" NPT 0.86 (21.84)	1-3/16 (30.16) 1-1/4 (31.75) 1 SQ. (25.4) 1-1/4" NPT 11/16 (17.46)	1-3/16 (30.16) 1-1/2 (38.1) 1-1/4 SQ. (31.8) 2" NPT 7/8 (22.23)	07-1/2 (190.5) 03/4" THRU. 90° APART EQ. SP. ON A 6±1/16" B.C. (4 HOLES) 1-3/16 (30.16) 1/2" NPT 3"-150# ANSI FLANGE 1 (25.4) 1/16 (1.59)
Stem & Mounting Material	Brass or 316 Stainless Steel				Flange: Carbon Steel or 316 S.S. Stem: 316 S.S.
Max Length (Lo)	36" (91.4 cm)	60" (152.4 cm)		140" (355.6 cm)	
Mounting Position	Vertical ± 30° Inclination				
Float Stops*	Brass Units: Beryllium Copper Grip Rings; Stainless Steel Units: S.S. ARMCO PH-15-7MO Grip Rings				

* Units greater than 72" overall length are supplied with collars with setscrews (made of same material as stem and mounting) in place of float-stop rings. Collars are optional on units less than 72" overall length. Units requiring 316 SS float stops must be special ordered with 316 SS collars instead of grip rings. In some instances, concentration of chlorine and other corrosive compounds in the media require the use of collar type float stops. Consult factory for details.

† Type 1 and Type 8 mountings not FM approved.

LEVEL SWITCHES – MULTI POINT

LS-800 Series – Continued

1. Mounting Types – continued

Type 5 External Mounting units are ideal for tanks with limited access to tops or bottoms.

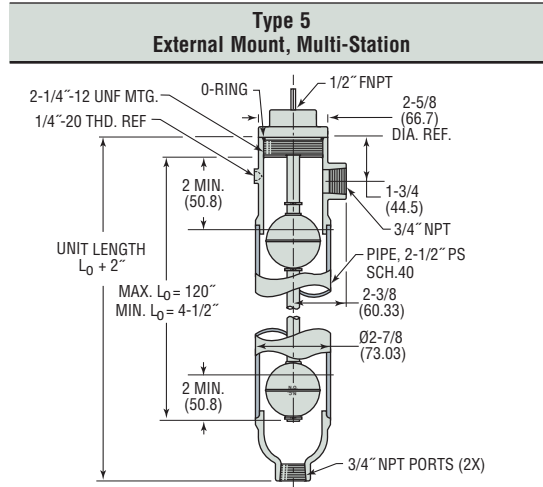

Housing Material	Brass	316 Stainless Steel
Stem and Mounting	Brass	316 Stainless Steel
Port Sizes	3/4" NPT	
Max. Length (Lo)	120" (305 cm)	
Float Stops*	Beryllium Copper	S.S. ARMCO PH-15-7 MO

* Units greater than 72" overall length are supplied with collars with setscrews (made of same material as stem and mounting) in place of float-stop rings. Collars are optional on units less than 72" overall length. Units requiring 316 SS float stops must be special ordered with 316 SS collars instead of grip rings. In some instances, concentration of chlorine and other corrosive compounds in the media require the use of collar type float stops. Consult factory for details.

2. Float Types

A single float type is selected for use at all actuation points. Be sure, by reviewing the table below, that the desired float is compatible with the Mounting Type selected in Step 1.

Float Material	Buna N				316 Stainless Steel		
Compatible Mounting Types	1, 2, 3, 4, 8	2	1, 3, 4, 5	3, 4, 5 (Units >72")	1, 3, 4, 5 (Units ≤72")	3, 4, 5 (Units >72")	1, 3, 4
Float Dimensions							
Part Number	253644	26032	10558	24864	14569	15666	138935
Operating Temperature	Water: to 180°F (82°C) Oil: -40°F to +230°F (-40°C to +110°C)				-40°F to +300°F (-40°C to +149°C)		
Min. Media Specific Gravity	0.55	0.75	0.55	0.55	0.75	0.75	0.80

Pressure Ratings Chart (PSI, Max.)

Mounting Type		Float Part Number						
		253644	26032	10558	24864	14569	15666	138935
		1, 2, 3	150				750	300
5	4	150					180	
	Brass	100 @ 70°F (21°C)						
	316 S.S.	150			750	300	120	

Review the Compatible Mounting Type row in the "Float Types" table above this matrix for producible mounting/float combinations. Not all combinations implied by this Pressure Rating Chart are possible or recommended.

LS-800-A Series Adjustable Mounting

Available for LS-800 Series Mounting Types 2, 3 and 4.

Special cinch-nut on mounting allows stem to travel up or down for fine tuning the actuation points. The extent of adjustment depends on unit length and distance from mounting to highest float stop. When ordering, specify "LS-800-A" as Series Type.

Note: Maximum overall length is limited to 72" with this option.

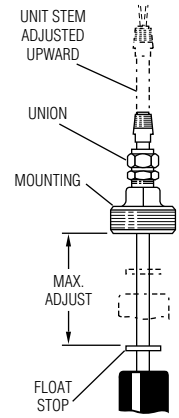

Intrinsically-Safe Relays

Using Gems SAFE-PAK® relays and barriers, these switches provide automatic refills/pumpdown and are intrinsically-safe without explosion-proof housing and piping.



See Section L

3. Electrical Specifications

Switch (N.O. or N.C.):

SPST: 20 VA or 100 VA

SPDT: 20 VA

Lead Wires: #18 AWG, 24" L., Polymeric (except as noted in Wiring Color Code chart at right).

Approvals: LS-800 Series switches are U.L. Recognized – File No. E45168; CSA Listed – File No. 30200

Typical Wiring Diagrams

For clarity, only two actuation levels are shown in each group diagram.

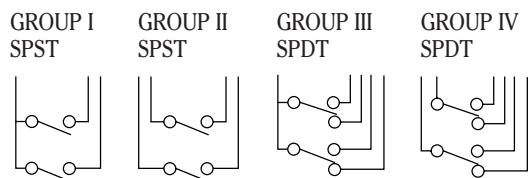

Wiring Color Code

Tinted area designates U.L. Recognized wiring configurations.

Wiring	SPST Switches			SPDT Switches 20 VA				
	Group I	Group II		Group III		Group IV		
Com. Wire	Black	None		Black		None		
	NO/NC	SW. Com.	NO/NC	NO	NC	SW. Com.	NO	NC
L1	Red	Red	Red	Red	Wh/Red	Red	Wh/Red	Wh/Blk/Red
L2	Yellow	Yellow	Yellow	Yellow	Wh/Yel	Yellow	Wh/Yel	Wh/Blk/Yel
L3	Blue	Blue	Blue	Blue	Wh/Blue	Blue	Wh/Blu	Wh/Blk/Blu
L4	Brown	Brown	Brown	Brown	Wh/Brn	Brown	Wh/Brn	Wh/Blk/Brn
L5	Orange	Orange	Orange	Orange	Wh/Orn	Orange	Wh/Orn	Wh/Blk/Orn
L6	Gray	Gray	Gray	Gray	Wh/Gra	Gray	Wh/Gra	Wh/Blk/Gra

Notes:

1. Non-U.L. Recognized units (white areas) use #22 AWG, 24" L., PTFE Lead wires.
2. Units with 100 VA switches are not U.L. Recognized or CSA Listed.
3. See "Electrical Data" on Page X-5 for more information.

4. Actuation Level Dimensions

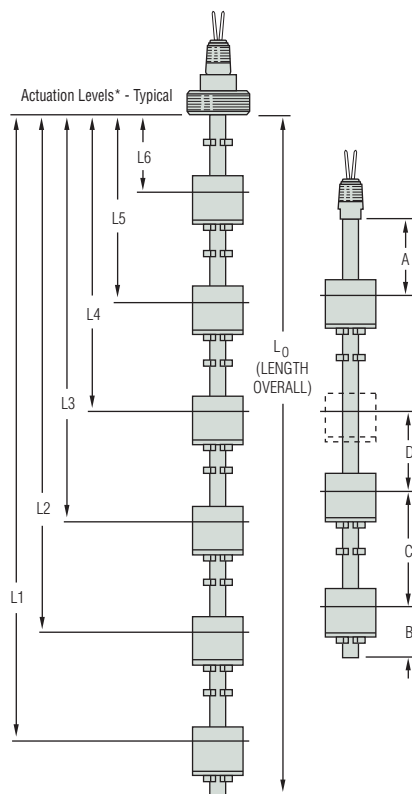

Switch actuation levels are determined following the guidelines below.

All units 72" or less L_0 with Stainless Steel or Buna N floats. Also any unit over 72" L_0 with Buna N floats:

A = 1-1/2" (38.1 mm) minimum distance to highest level (2", Type 5 only).

B = 2" (50.8 mm) minimum distance from end of unit to lowest level.

C = 3" (76.2 mm) minimum distance between levels.

D = 1/4" (6.3 mm) minimum distance between actuation levels (Note: One float for two levels can be used only when low level is N.C. dry and high level is N.O. dry).

Types 1, 3, 4, and 5 units with stainless steel float, Part Number 15666:

A = 1-5/8" (41.3 mm) minimum distance to highest level (2", Type 5 only).

B = 2-1/2" (63.5 mm) minimum distance from end of unit to lowest level.

C = 4" (101.6 mm) minimum distance between level.

D = 1/4" (6.3 mm) minimum distance between actuation levels (Note: One float for two levels can be used only when low level is N.C. dry and high level is N.O. dry).

Notes:

1. A, B and C dimensions based on a liquid specific gravity of 1.0.
2. One float for two levels can be used only when 20VA switch is used.
3. Actuation levels are calibrated on descending fluid level, with water as the calibrating fluid, unless otherwise specified.
4. Tolerance on actuation levels is $\pm 1/8"$ (3.2 mm).
5. TH (Temperature option) makes "B" dimension a minimum of 2.75" (69.8 mm).

* Actuation level distances and L_0 (overall unit length) are measured from inner surfaces of mounting plug or flange.

** Length Overall $L_0 = L_1 + \text{Dimension B}$.

See Mounting Types for Maximum Length values.

Optional Integrated Temperature Sensors

- ▶ Compatible with LS-700 and LS-800 Series Units
- ▶ Thermostat Switches or Thermistor Versions

Advantages of integrated temperature sensors:

- Space Saving.
- Fewer intrusions into the tank.
- Electrical wiring emanates from a single source – eliminate multiple conduits.
- Economical – typically less expensive than separate sensors.

Look for units in this catalog with the temperature sensor icon:

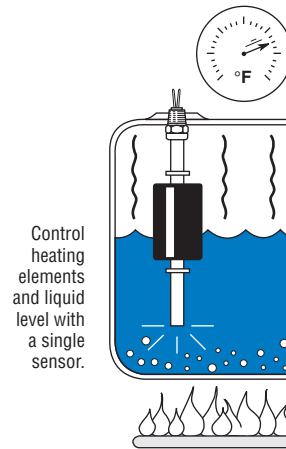

Thermistor for Continuous Indication – TM-800 and TM-700

- Excellent repeatability.

Value: 10,000 ohms @ 77°F (25°C)

Tolerance: ±0.2°C from 32°F to 158°F (0°C to 70°C)

Operating Temperature: 302°F (150°C), Max.

Alpha @ 25°C: -4.39%/°C

Dissipation Constant: 1mW/°C in Still Air;
8mW/°C in Oil Bath.

How to Order

Temperature thermistors are available on LS-700 Series units with up to three actuation levels, and on LS-800 Series units with up to five actuation levels. To have thermistor added, order model TM-800 or TM-700.

Note: This option is not CE Approved.

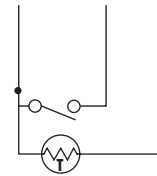

GROUP I

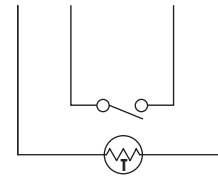

GROUP II

Thermostat for Switch Actuation

- Standard Settings from 100°F to 200°F.
- Open or close switch on increasing temperature.

Use these switches to set off High/Low temperature alarms. Or, combine with GEMS relays to control tank heating and cooling, motor-operated valves, etc.

To designate the thermostat switch option, order model TH-700 or TH-800. Also specify the choice from selections A, B and C below.

- Switch Rating:**
For LS-800 Series: 6A/120V, 4A/240V, 100VA (non-inductive).
For LS-700 Series: 2.6A/120V (inductive).
- Contact Operation on Increasing Temperature:**
“Opens” when Set Point reached or “Closes” when Set Point reached.
- Standard Temperature Set Point (±7.2°F; ±4°C):**
100°F (37.7°C), 125°F (51.6°C), 150°F (65.6°C), 175°F (79.4°C), 200°F (93.3°C)

Note:

- Other temperature settings and tolerances available; 25 piece minimum order quantity applies. Please call GEMS Sensors Inc. for more information.
- This option is not CE Approved.

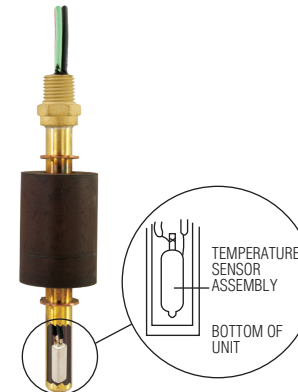

Note: End of unit stem must be submerged a minimum of 2-3/4” for level switch actuation.

Typical Wiring Diagram

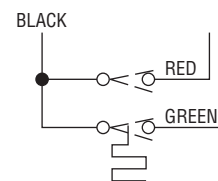

GROUP I

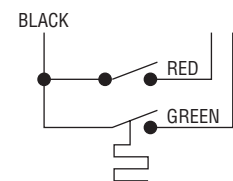

GROUP II

 <p>Photocopy This Form Use one form for each product type you are selecting. This form may also be completed online at gemsensors.com for RFQ.</p>	This is a Request for a Quote Order P.O. _____ Quantity Needed _____ Date Required ____/____/____ Shipping Method: _____ Partial Accepted: Yes No	Name _____ Company _____ Street _____ City _____ State ____ Zip _____ Phone (____) _____ Fax (____) _____
---	--	--

LS-800 Types Custom Length Float Type Level Switches

Application Environmental Conditions

This information is essential to the accurate and proper operation of your GEMS configurable sensor. Please complete fully and accurately before ordering.

1. **Liquid Media:** _____
2. **Pressure:** Minimum _____ psig Maximum _____ bar
3. **Temperature:** Minimum _____ °F Maximum _____ °C
4. **Specific Gravity:** Minimum _____ Maximum _____

5. **Viscosity:** _____ SSU
6. **Tank Material:** _____
Tank Depth: _____
7. **Unit is Mounted In:** Top Mounted Bottom Mounted

1. Series (Page No.):

- LS-800PVC (B-18) LSP-800 (B-20) LS-800 (B-22)
 LS-800-Adjustable (B-23)
 TM-800 (B-25. Thermistor Equipped)
 TH-800 (B-25. Thermostat Equipped)

See product page number for available mounting type and materials.

2. Mounting Type:

- | | | |
|--------|--------|--------|
| Type A | Type B | Type C |
| Type 1 | Type 2 | Type 3 |
| Type 4 | Type 5 | Type 8 |

3. Mounting and Stem Material (if choice available):

- | | |
|---------------------|---|
| Brass | Polypropylene |
| PVC | PVDF |
| 316 Stainless Steel | Carbon Steel (Flanges Only, in association with stainless steel stems.) |

4. Mounting Position:

- Tank Top Tank Bottom

5. Float Part Number: _____

Matching floats will be used at each actuation level specified.

6. Switch Type and Rating:

- A. Group I Group II
 Group III* Group IV*
- B. SPST SPDT*
- C. 20 VA 100 VA (SPST only)
- Please indicate if using microprocessor/PLC load: Yes No

* Not Available on the TM-800 Series.

Please contact GEMS Sensors Inc. for any configuration or special requirements not covered on this form. **800-378-1600**

Quote: \$ _____ Date Quoted: ____/____/____

Additional minimum charges may apply on special orders.

7. Switch Actuation Level

Actuation Level	Distance to Actuation Level (Inches) ¹	SPST Switch Operation ² (Check Type)	
		N.O.	N.C.
L6			
L5			
L4			
L3			
L2			
L1 ³			

Notes:

1. Measured from inner surface of mounting plug or flange.
2. Switch position is "normal" with unit dry (tank empty).
3. L1 is the distance to the lowest actuation level with mounting "up," and is the distance to the highest actuation level with mounting "down."
4. Float stops are standard; see B-24 for specifications.

- B. Length Overall (L₀) _____ inches (customer supplied support bracket assembly recommended for lengths over 72".)

8. Lead Wire Length:

12" 24" Other: _____ inches.

Options:

Temperature Switch Settings (°F):	100 125 150
	175 200
On rising temperature, switch...	Opens Closes
Slosh Shield	316 SS (316 SS units only) Brass (Brass units only)

J-Box Electrical Connection:

Explosion Proof Type (FM/CSA)*
 NEMA 4 Type Plastic ABS Type

* Requires stainless steel floats

